Table of Contents

Safety statement.....	2
Overviews	3-6
Miniatures.....	7-10
Filters	11-14
Manual in-line desiccant dryer	15
Regulators	15-19
Filter/regulators	20-21
Lubricators	21-24
Combination units.....	24-28
Exhaust mufflers.....	28
Automatic drains.....	29
Lockout valves	29
Accessories and repair kits	30-34
Cross references	36-37

Safety Recommendations

Air Prep Units:

Air preparation units (FRLs) must be properly maintained if reasonable service life is to be expected. The proper function of these units is essential to safety, performance, and the extension of service life of the pneumatic tools involved. Filters must be properly drained and the filter elements must be cleaned or replaced as necessary. The regulators should be periodically checked for pressure accuracy. Lubricators must be checked to ensure there is always lubricant available in the reservoir of the air tool. Be sure to use only lubricants that are recommended for this service and never consider a substitution without contacting the manufacturer of the unit. See page 34 for additional information on the use of lubricants.

FRL Brackets:

Consideration should be given to properly supporting pneumatic preparation units (FRLs in an air system).

Unsupported preparation units can lead to leaks within the piping system that may promote safety and efficiency problems. Mounting brackets are offered on page 34.

General Safety

Dixon's couplings and retention devices are designed to work safely for their intended use. The selection of the proper hose, coupling, and retention device, and the proper application of the coupling to the hose are of utmost importance.

Users must consider the size, temperature, application, media, pressure, and hose and coupling manufacturer's recommendations when selecting the proper hose assembly components. Dixon® recommends that all hose assemblies be tested in accordance with the Association for Rubber Products Manufacturer's (ARPM) recommendations and be inspected regularly (before each use) to ensure that they are not damaged or have become loose. Visit ARPMINC.com for more information.

Where safety devices are integral to the coupling, they must be working and utilized. The use of supplementary safety devices such as safety clips or safety cables are recommended.

If any problem is detected, couplings must be removed from service immediately.

Dixon is available to consult, train, and recommend the proper selection and application of all fittings we sell. We strongly recommend that distributors and end users make use of Dixon's testing and recommendation services. Call 877.963.4966 or visit dixonvalve.com learn more.

Filter Overview

Airborne contamination from the atmosphere, such as dust, water vapor, and hydrocarbons, enter the air system through the compressor intake. The contaminants, usually 4 million particles per cubic foot, can easily pass through a typical compressor intake filter since over 80% of these particles are less than 2 microns in size. The compressor also contributes to the problem with wear particles, oil vapor, and fine aerosols that leak past glands and seals from the oil sump into the compression chamber.

Such contamination in the air system may interfere with the efficient operation of various pneumatic devices and, over time, damage them. Compressed air filters that are installed upstream of the air devices will remove most of these contaminants. In addition, these filters will also remove most liquid water from the air line.

To gain improved production efficiencies through automation, more sophisticated, technically advanced pneumatic equipment and instrumentation is being used throughout the industry. Due to the critical nature of these applications, the need for extremely clean, virtually oil free air is required. Coalescing (oil removal) and oil vapor removal filters should be used for applications requiring high quality air.

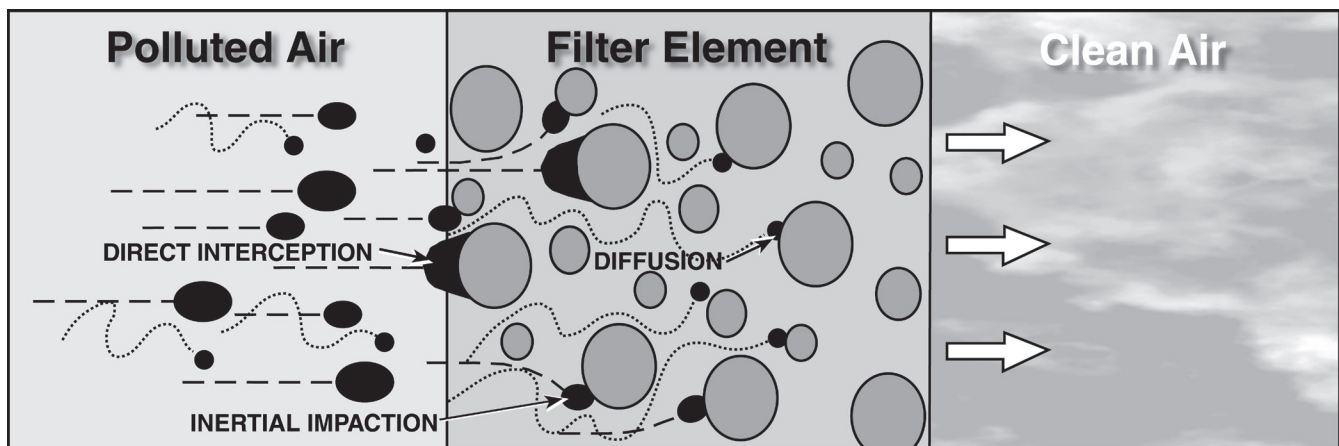

When Making Your Filter Selection:

1. Generally install filters downstream of aftercoolers/separators and air receivers at the lowest temperature point and as close to the point of application as possible. This reduces the chance of additional water and oil vapor condensing after the filter.
2. Filters should not be installed downstream of quick opening valves and should be protected from possible reverse flow or other shock conditions.
3. It may be necessary to install a combination of mainline filtration near the compressor installation before entry to the main air distribution system, as well as installing terminal filtration at the critical application points. Remember, especially in existing installations, the contamination already in the pipe system downstream of the filters will take a long time to disappear and probably never will completely.
4. Purge all lines leading from the filters to the final application to be protected.
5. Install filters in a vertical position ensuring that there is sufficient room below the filters to facilitate element change.
6. Provide a facility to drain away collected liquids from the filter drains via properly sized tubing, taking care there are no restrictions in the drain line.
7. Install a Wilkerson differential pressure gauge or pop-up indicator to monitor the pressure drop across the filters. This will provide an easy way of visually monitoring the filter element condition, indicating when to replace the element. If you have a problem with filter selection or installation please contact Dixon®.
8. It is recommended to pipe the system with bypass circuits and isolation valves for piping convenience and to minimize air system disruptions.

Filter Overview

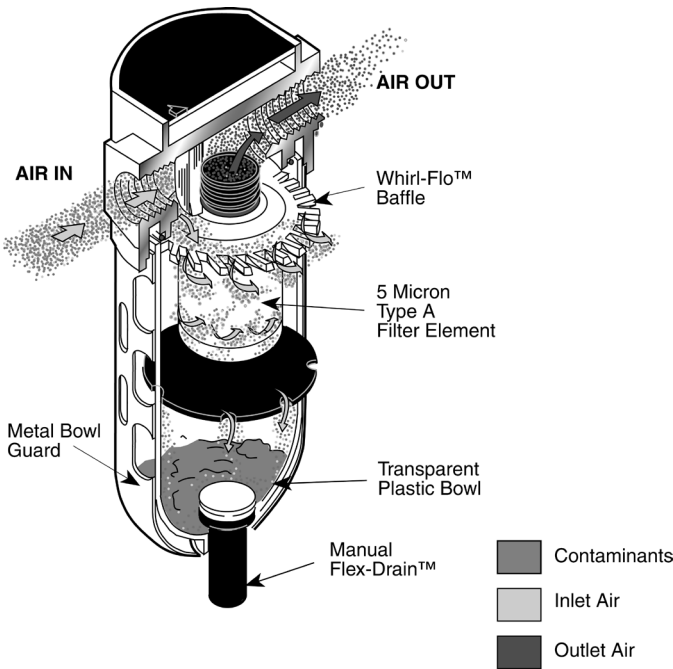

Particulate Filters

For the removal of solid particle contaminants down to five microns and the separation of bulk liquids. This type of filter is generally used in industrial applications where water, oil, and harmful dirt particles must be removed from the compressed air system. This type of filter should also be used as a prefilter for the coalescing (oil removal) filter.

Operation

Wet and dirty inlet air is directed downward and outward in a circular pattern by the turbine-shaped upper baffle. This action mechanically separates a large amount of the liquid and gross particles, which then flow down the inside of the bowl, past the lower baffle, into the quiet zone to be drained away. The quiet zone baffle prevents the contaminants from reentering the air flow stream. The partially cleansed air then passes through the filter element. By utilizing depth filtration, the 5 micron filter provides superior filtration, exceptional service life, and minimum pressure drop.

Coalescing Filters (Oil Removal)

Specifically designed for the removal of solid particles, water, and oil aerosols down to 0.01 microns. The maximum remaining oil content of air leaving the filter drops down to 0.01ppm at 70°F (21°C) at a pressure of 100 PSIG (6,9 bar) using a typical compressor lubricant. Specific end-use applications are protection of critical air control circuits, air logic systems, flow and temperature controllers, food processing, electronics, health care, and film processing.

Operation

The filter element utilizes a borosilicate microfiber that provides superior filtration efficiency, quick draining, and minimum pressure drop. Unlike standard particle filters, air flow is inside to out. The compressed air/gas passes through the inner layer of the filter element which acts as an integral pre-filter to remove large contaminants. This gives protection to the layer of high efficiency filter material which substantially removes submicronic aerosols and solids from the air flow stream. Solid particles are permanently trapped within the filter media.

The fine liquid particles, including aerosols, after initially being trapped by the fibers of the filter media, begin to collect or coalesce forming larger droplets. These droplets, along with other large droplets present, are pushed to the outer surface. Here, the anti-re-entrainment barrier collects the droplets as they break free from the microfiber and allows them to gravitate within its cellular structure forming a "wet band" around the bottom of the element.

Clean filtered air/gas passes through the anti-re-entrainment barrier above the "wet-band" where the resistance to flow is less, leaving a quiet zone of no air/gas movement in the bottom of the filter housing. The separated liquid drops from the bottom of the filter element and falls through without being reentrained, to the bottom of the filter housing where it collects to be removed by a drain.

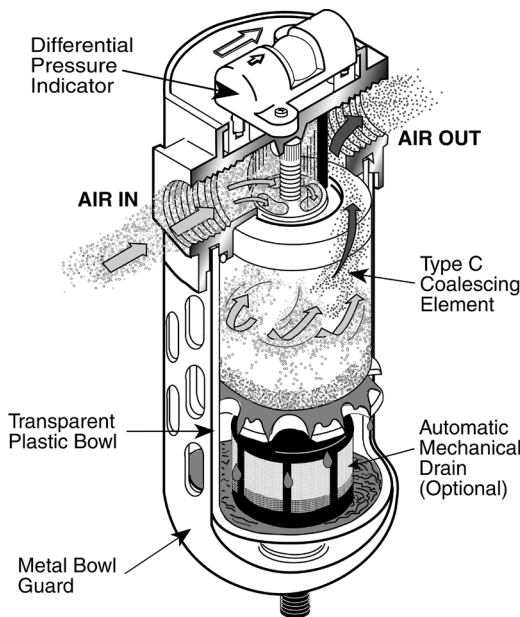

Regulator Overview

All pneumatic devices are designed to provide optimum performance and service life at a specific air pressure. While it is feasible to operate these devices at pressures in excess of the manufacturer's recommended operating conditions, it is not advisable to do so. Operating at higher pressures can cause excessive wear and damage to the device. Operating your compressed air system at a higher-than-required pressure wastes energy and is not cost-effective.

To obtain the best operation and service life from your pneumatic equipment use the proper pressure level recommended by the manufacturer. A regulator (pressure control valve) is normally used to reduce and maintain a downstream pressure while the amount of air required to the device may vary with the demand. This type of regulator is generally used in a wide variety of applications where reduced pressure is highly desirable for energy conservation, safety requirements, air circuit control, and air instrumentation.

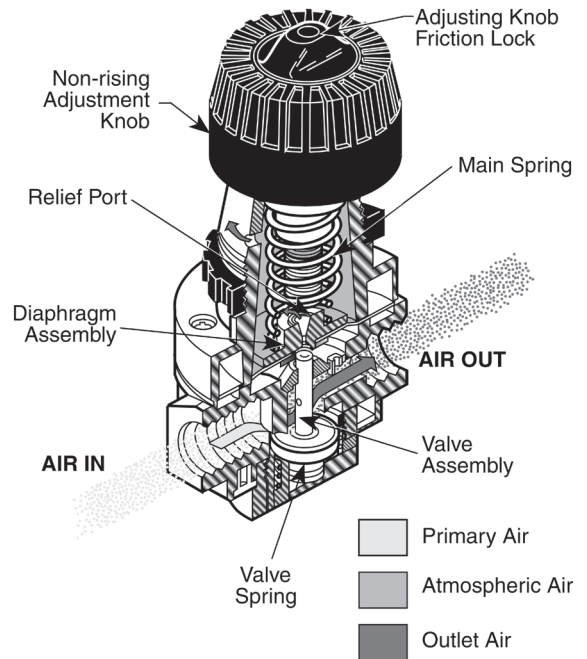

Operation

Turning the adjusting knob clockwise forces the main spring downward onto the flexible diaphragm, which presses down onto the valve stem. The diaphragm and valve stem move downward forcing the balanced valve off its seat, which allows air to flow past the valve to the outlet side of the regulator and downstream to the air system. A precisely positioned aspirator tube communicates secondary pressure to the diaphragm resulting in instant compensation in order to maintain the desired secondary set pressure.

The diaphragm, valve stem, and valve move upward, compressing the regulating main spring. Upward movement stops when the spring force acting on the diaphragm balances the pressure force acting below the diaphragm. For best performance, regulated pressure should always be set by increasing the pressure up to the desired setting.

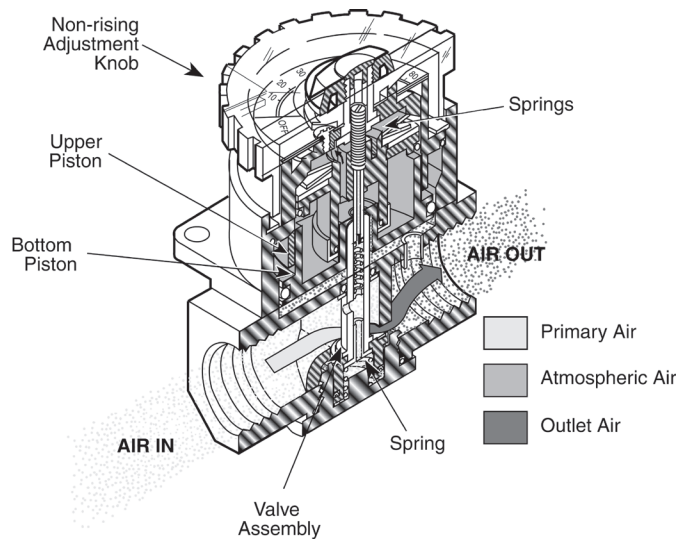

Lubricator Overview

Getting the proper lubrication to the proper device at the proper time is fundamental to preventative maintenance, longer service life, and increased productivity. The efficiency of air motors, control valves, cylinders, and other air actuators can be greatly enhanced when the proper amount of lubrication is supplied.

Air line lubricators are specifically designed to generate and introduce an oil aerosol (mist) into the compressed air flow.

The air flow then carries the oil to the pneumatic devices where the lubricant mist coats the moving and sliding surfaces thus reducing friction and wear.

To provide satisfactory lubrication to your air devices most lubricators have a proportional delivery system. This feature automatically provides a nearly constant oil-to-air ratio over a wide range of air flows.

Operation

For proper operation there must be line pressure in the reservoir bowl. As the air flows through the lubricator, some of the incoming air passes through the bowl pressure control valve which then pressurizes the bowl pushing oil upward through the siphon tube. Most of the air flow passes through the self-adjusting Flow-Guide® flow sensor in the lubricator throat creating a slight pressure drop that is proportional to the rate of air flow. The pressure drop is sensed by the sight dome and the adjustment needle valve allowing oil to flow upward through the siphon tube into the sight dome where it drips into a nozzle passage and then into the lubricator throat.

The precise amount of oil to be delivered to the air stream is determined by the oil adjusting needle valve which sets the exact drip rate. The oil drops are atomized by the high velocity air flowing through the lubricator. All of the drops visible in the sight dome are delivered downstream to the air devices.

The self-adjusting flow sensor automatically maintains a constant oil-to-air ratio by opening and closing in response to a wide range of changing air flows. A check valve keeps the siphon tube full of oil during periods of no flow and prevents oil carry-over due to the possibility of reverse flow.

The pressurizing valve controls the rate of bowl pressurization and allows depressurization for refilling the unit without shutting off the supply air. When the oil fill plug is loosened, a spring-loaded 2-way valve closes, allowing the air pressure in the bowl to be gradually reduced. When the fill plug is replaced, the bowl repressurizes through the pressure control valve. Upon initial use, or if unit has been run dry, open oil adjustment wide open until no air bubbles are visible in sight dome. Then, reset oil feed adjustment to desired setting.

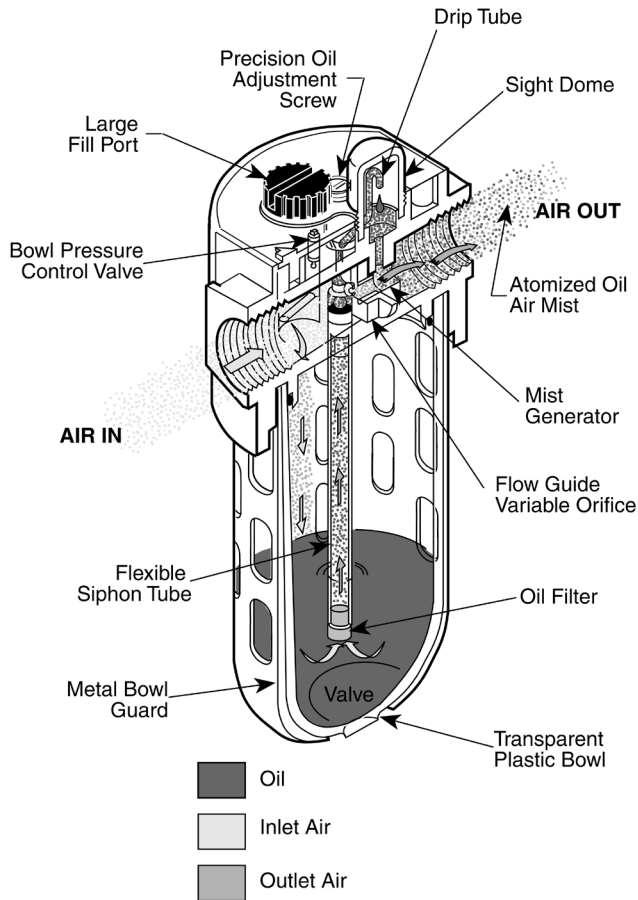

F03-Series Miniature Filters

Features

- Excellent water removal efficiency
- 5 micron element
- .5 oz. bowl

Specifications

- Maximum operating conditions:
 - transparent bowl: 150 PSIG (10.3 bar) and 32°F to 125°F (0°C to 52°C)
 - metal bowl: 250 PSIG (17.2 bar) and 32°F to 175°F (0°C to 80°C)

Port Size	Flow (SCFM)	Transparent Bowl		Metal Bowl	
		Automatic Drain Part #	Manual Drain Part #	Automatic Drain Part #	Manual Drain Part #
1/8"	22	F03-01A	F03-01M	F03-01AMB	F03-01MMB
1/4"	24	F03-02A	F03-02M	F03-02AMB	F03-02MMB

NOTE: SCFM ratings at 90 PSIG inlet pressure.



Transparent bowl

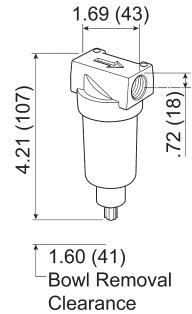

F08-Series Miniature Filters

Features

- 5 micron element
- .6 oz. bowl

Specifications

- Maximum operating conditions:
 - transparent bowl: 150 PSIG (10.3 bar) and 14°F to 125°F (-10°C to 52°C)
 - metal bowl: 250 PSIG (17.2 bar) and 14°F to 150°F (-10°C to 65.5°C)

Port Size	Flow (SCFM)	Transparent Bowl and Guard		Metal Bowl	
		Automatic Drain Part #	Manual Drain Part #	Automatic Drain Part #	Manual Drain Part #
1/4"	42	F08-02A	F08-02M	F08-02AMB	F08-02MMB

NOTE: See pages 30-34 for accessories.
SCFM ratings at 150 PSIG inlet pressure.



Metal bowl

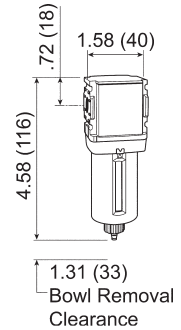

R03-Series Miniature Regulators

Features

- 2-125 PSI adjusting range
- Balanced valve design
- Self-relieving standard
- Non-rising push/pull locking adjustment knob
- Two 1/8" NPT gauge ports standard on models without gauge, one 1/8" NPT gauge port standard on models with gauge - can be used for additional outlet ports
- Models supplied without gauge use a GC620 gauge
- Panel mount nuts sold separately

Specifications

- Maximum operating conditions: 300 PSIG (20.17 bar) and 32°F to 125°F (0°C to 52°C)

Size	Flow (SCFM)	With Gauge Part #	Without Gauge Part #
1/8"	13	R03-01RG	R03-01R
1/4"	15	R03-02RG	R03-02R

NOTE: See pages 30-34 for accessories.
SCFM ratings at 100 PSIG inlet pressure.
FRLs are designed for air service only, unless otherwise indicated.

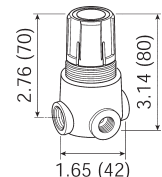

R08-Series Miniature Regulators

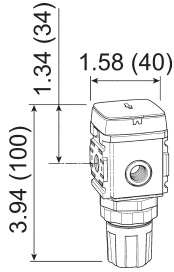

Features

- 0-125 PSI adjusting range
- Balanced valve design
- Self-relieving standard
- Non-rising push/pull locking adjustment knob
- Two 1/8" NPT gauge ports standard on models without gauge, one 1/8" NPT gauge port standard on models with gauge - can be used for additional outlet ports.
- Models with gauge are supplied with a 0-160 PSI flush mount style gauge
- Models supplied without gauge use a GC620 gauge.
- Panel mount nuts sold separately

Specifications

- Maximum operating conditions:
- 300 PSIG (20.7 bar) and -4°F to 150°F (-20°C to 65.5°C)

Size	Flow (SCFM)	With Gauge Part #	Without Gauge Part #
1/4"	68	R08-02RG	R08-02R

NOTE: SCFM ratings at 100 PSIG inlet pressure.

RB3-Series Miniature Water Regulators

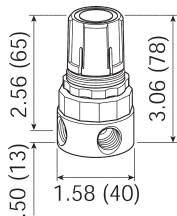

Features

- 2-125 PSI adjusting range
- Suitable for water and compressed air service
- Brass construction - wetted parts
- Non-relieving spring-loaded diaphragm
- Panel mount nut included
- Two 1/8" NPT gauge ports standard
- Models supplied without gauge use a GC620 gauge

Specifications

- Maximum operating conditions:
- 300 PSIG (20.7 bar) and 40°F to 125°F (4°C to 52°C)

Size	Flow (SCFM)	With Gauge Part #	Without Gauge Part #
1/8"	11	RB3-01RG	RB3-01R
1/4"	14	RB3-02RG	RB3-02R

NOTE: See pages 30-34 for accessories.
SCFM ratings at 100 PSIG inlet pressure.

BB3-Series Miniature Filters/Regulators

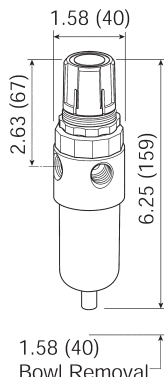

Transparent bowl

Features

- 2-125 PSI adjusting range
- 5 micron element
- .5 oz. bowl
- Self-relieving
- Supplied with a GC620 gauge

Specifications

- Maximum operating conditions:
- transparent bowl: 125 PSIG (8.6 bar) and 40°F to 125°F (4.4°C to 52°C)
- metal bowl: 300 PSIG (20.7 bar) and 40°F to 125°F (4.4°C to 52°C)

Port Size	Flow (SCFM)	Transparent Bowl		Metal Bowl	
		Automatic Drain Part #	Manual Drain Part #	Automatic Drain Part #	Manual Drain Part #
1/8"	13	BB3-01AG	BB3-01MG	---	BB3-01MGMB
1/4"	16	BB3-02AG	BB3-02MG	BB3-02AGMB	BB3-02MGMB

NOTE: SCFM ratings at 150 PSIG inlet pressure.
FRLs are designed for air service only, unless otherwise indicated.

B08-Series Miniature Filters/Regulators

Features

- 0-125 PSI adjusting range
- 5 micron element
- .4 oz. bowl
- Self-relieving
- Supplied with a 0-160 PSI flush mount style gauge

Specifications

- Maximum operating conditions:
 - transparent bowl: 150 PSIG (10.3 bar) and 14°F to 125°F (-10°C to 52°C)
 - metal bowl: 250 PSIG (17.2 bar) and 14°F to 150°F (-10°C to 65.5°C)

Size	Flow (SCFM)	Transparent Bowl and Guard		Metal Bowl	
		Automatic Drain Part #	Manual Drain Part #	Automatic Drain Part #	Manual Drain Part #
1/4"	73	B08-02AG	B08-02MG	B08-02AGMB	B08-02MGMB

NOTE: See pages 30-34 for accessories.
SCFM ratings at 100 PSIG inlet pressure.

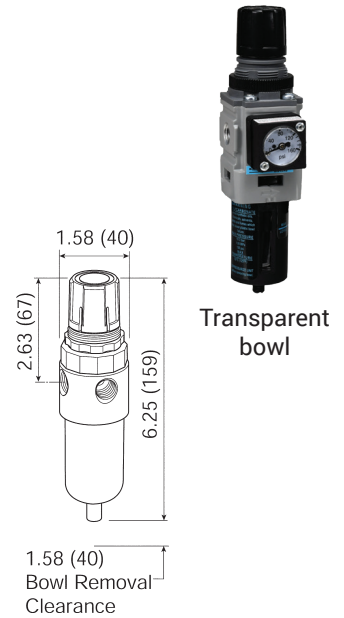

Transparent bowl

L03-Series Miniature Lubricators

Features

- 1 oz. bowl
- Adjustable oil feed
- Full view sight dome
- Do not fill under pressure, air supply must be turned off and pressure bled from unit prior to adding oil



Specifications

- Maximum operating conditions:
 - transparent bowl: 150 PSIG (10.3 bar) and 32°F to 125°F (0°C to 52°C)
 - metal bowl: 250 PSIG (17.2 bar) and 32°F to 175°F (0°C to 80°C)

Size	Flow (SCFM)	Transparent Bowl Part #	Metal Bowl Part #
1/8"	20	L03-01A	L03-01AMB
1/4"	20	L03-02A	L03-02AMB

NOTE: SCFM ratings at 90 PSIG inlet pressure.

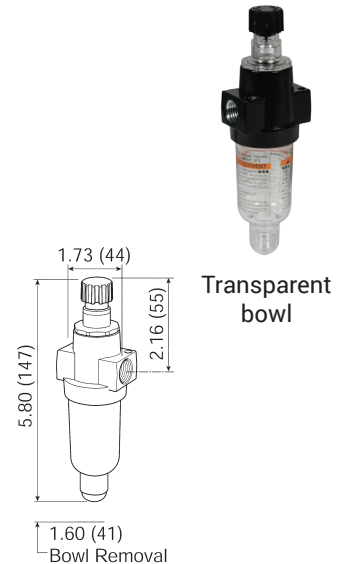

Transparent bowl

L08-Series Miniature Lubricators

Features

- .6 oz. bowl
- Adjustable oil feed
- Full view sight dome
- Fill under pressure design

Specifications

- Maximum operating conditions:
 - transparent bowl: 150 PSIG (10.3 bar) and 14°F to 125°F (-10°C to 52°C)
 - metal bowl: 250 PSIG (17.2 bar) and 14°F to 150°F (-10°C to 65.5°C)

Size	Flow (SCFM)	Transparent Bowl Part #	Metal Bowl Part #
1/4"	52	L08-02A	L08-02AMB

NOTE: See pages 30-34 for accessories.
See page 34 for air tool lubricant.
SCFM ratings at 150 PSIG inlet pressure.
FRLs are designed for air service only, unless otherwise indicated.

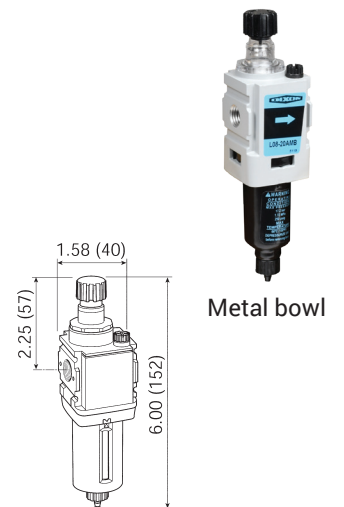

Metal bowl

C03-Series Miniature Combination Units

Features

- Included components: (2) adapters

Filter series F03:

- 5 micron element
- .5 oz. bowl

Regulator series R03:

- 2-125 PSI adjusting range
- Balanced valve design
- Self-relieving
- Supplied with a GC620 gauge
- Can be mounted with knob in up or down position

Lubricator series L03:

- 1 oz. bowl
- Adjustable oil feed
- Full view sight dome

Specifications

- Maximum operating conditions:
 - transparent bowl: 150 PSIG (10.3 bar) and 32°F to 125°F (0°C to 52°C)
 - metal bowl: 250 PSIG (17.2 bar) and 32°F to 175°F (0°C to 80°C)



Transparent bowl

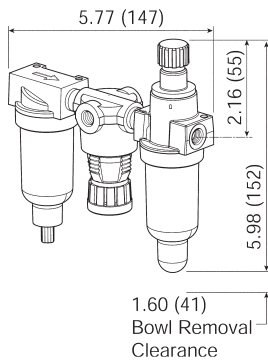

Size	Flow (SCFM)	Transparent Bowl and Guard		Metal Bowl	
		Automatic Drain Part #	Manual Drain Part #	Automatic Drain Part #	Manual Drain Part #
1/8"	20	C03-01A	C03-01M	C03-01AMB	C03-01MMB
1/4"	20	C03-02A	C03-02M	C03-02AMB	C03-02MMB

NOTE: SCFM ratings at 100 PSIG inlet pressure.

C08-Series Miniature Combination Units

Features

- Included components: (2) mounting brackets with joiner set

Filter series F08:

- 5 micron element
- .6 oz. bowl

Regulator series R08:

- 0-125 PSI adjusting range
- Balanced valve design
- Self-relieving
- Supplied with a 0-160 PSI flush mount style gauge

Lubricator series L08:

- .6 oz. bowl
- Adjustable oil feed
- Full view sight dome

Specifications

- Maximum operating conditions:
 - transparent bowl: 150 PSIG (10.3 bar) and 14°F to 125°F (-10°C to 52°C)
 - metal bowl: 250 PSIG (17.2 bar) and 14°F to 150°F (-10°C to 65.5°C)



Metal bowl

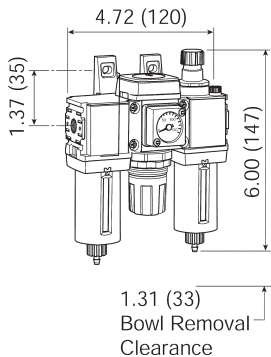

Size	Flow (SCFM)	Transparent Bowl and Guard		Metal Bowl	
		Automatic Drain Part #	Manual Drain Part #	Automatic Drain Part #	Manual Drain Part #
1/4"	27	C08-02A	C08-02M	C08-02AMB	C08-02MMB

NOTE: SCFM ratings at 100 PSIG inlet pressure.

FRLs are designed for air service only, unless otherwise indicated.

F16-Series Compact Airline Filters

Features

- 5 micron element
- 2.7 oz. bowl

Specifications

- Maximum operating conditions:
 - transparent bowl: 150 PSIG (10.3 bar) and 32°F to 125°F (0°C to 52°C)
 - metal bowl: 200 PSIG (13.8 bar) and 32°F to 150°F (0°C to 65.5°C)

Size	Flow (SCFM)	Transparent Bowl and Guard		Metal Bowl	
		Automatic Drain Part #	Manual Drain Part #	Automatic Drain Part #	Manual Drain Part #
1/4"	63.0	F16-02A	F16-02M	F16-02AMB	F16-02MMB
3/8"	74.1	F16-03A	F16-03M	---	F16-03MMB
1/2"	80.4	F16-04A	F16-04M	F16-04AMB	F16-04MMB

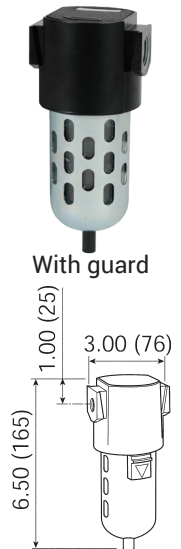

F18-Series Compact Airline Filters

Features

- High flow capacity
- 5 micron element
- 1.72 oz. bowl

Specifications

- Maximum operating conditions:
 - transparent bowl: 150 PSIG (10.3 bar) and -13°F to 125°F (-25°C to 52°C)
 - metal bowl: 250 PSIG (17.2 bar) and -13°F to 150°F (-25°C to 65.5°C)

Size	Flow (SCFM)	Transparent Bowl and Guard		Metal Bowl with Sight Glass	
		Automatic Drain Part #	Manual Drain Part #	Automatic Drain Part #	Manual Drain Part #
1/4"	50	F18-02A	F18-02M	F18-02AMB	F18-02MMB
3/8"	78	F18-03A	F18-03M	F18-03AMB	F18-03MMB
1/2"	82	F18-04A	F18-04M	F18-04AMB	F18-04MMB

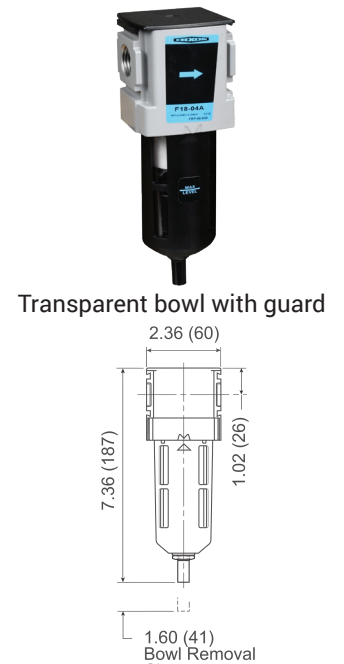

F26-Series Standard Airline Filters

Features

- 5 micron element
- 3.2 oz. bowl

Specifications

- Maximum operating conditions:
 - transparent bowl: 150 PSIG (10.3 bar) and 32°F to 125°F (0°C to 52°C)
 - metal bowl: 200 PSIG (13.8 bar) and 32°F to 150°F (0°C to 65.5°C)

Size	Flow (SCFM)	Transparent Bowl and Guard		Metal Bowl with Sight Glass	
		Automatic Drain Part #	Manual Drain Part #	Automatic Drain Part #	Manual Drain Part #
3/8"	117.8	F26-03A	F26-03M	F26-03AMB	F26-03MMB
1/2"	149.8	F26-04A	F26-04M	F26-04AMB	F26-04MMB



NOTE: SCFM ratings at 150 PSIG inlet pressure.

See pages 30-34 for accessories.

FRLs are designed for air service only, unless otherwise indicated. 



Transparent bowl with guard

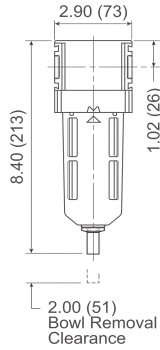

F28-Series Standard Airline Filters

Features

- High flow capacity
- 5 micron element
- 2.87 oz. bowl

Specifications

- Maximum operating conditions:
 - transparent bowl: 150 PSIG (10.3 bar) and -13°F to 125°F (-25°C to 52°C)
 - metal bowl: 250 PSIG (17.2 bar) and -13°F to 150°F (-25.5°C to 65.5°C)

Size	Flow (SCFM)	Transparent Bowl and Guard		Metal Bowl with Sight Glass	
		Automatic Drain Part #	Manual Drain Part #	Automatic Drain Part #	Manual Drain Part #
3/8"	115	F28-03A	F28-03M	F28-03AMB	F28-03MMB
1/2"	120	F28-04A	F28-04M	F28-04AMB	F28-04MMB
3/4"	145	F28-06A	F28-06M	F28-06AMB	F28-06MMB

F30-Series Jumbo Airline Filters

Features

- 5 micron element
- 2 oz. bowl

Specifications

- Maximum operating conditions:
 - transparent bowl: 150 PSIG (10.3 bar) and 32°F to 125°F (0°C to 52°C)
 - metal bowl: 200 PSIG (13.8 bar) and 32°F to 150°F (0°C to 65.5°C)

Size	Flow (SCFM)	Transparent Bowl and Guard		Metal Bowl with Sight Glass	
		Automatic Drain Part #	Manual Drain Part #	Automatic Drain Part #	Manual Drain Part #
3/4"	316	F30-06A	F30-06M	F30-06AMB	F30-06MMB
1"	323	F30-08A	F30-08M	F30-08AMB	F30-08MMB



With guard

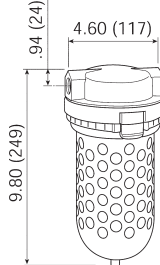

F35-Series Jumbo Airline Filters

Features

- 5 micron element
- 12.5 oz. bowl

Specifications

- Maximum operating conditions:
 - metal bowl: 150 PSIG (10.3 bar) and 32°F to 150°F (0°C to 65.5°C)

Size	Flow (SCFM)	Heavy Duty Metal Bowl	
		Automatic Drain Part #	Manual Drain Part #
1-1/2"	1280	F35-0BAMB	F35-0BMMB
2"	1400	F35-0CAMB	F35-0CMMB



With metal bowl

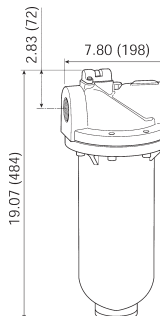

NOTE: SCFM ratings at 150 PSIG inlet pressure.
See pages 30-34 for accessories.

FRLs are designed for air service only, unless otherwise indicated.

M16-Series Compact Coalescing Filters

Features

- 0.01 micron type C element
- 2.7 oz. bowl
- Can be installed in modular system
- Removes extremely fine oil mists, oil aerosols, and microscopic particles
- A standard airline filter should be installed as a pre-filter when using a coalescing filter
- 0.5 micron type B and 0.003 micron type D elements are optional
- Differential pressure indicator changes from green to red with pressure loss



Specifications

- Maximum operating conditions: 150 PSIG (10.3 bar) and 32°F to 125°F (0°C to 52°C)

Size	Flow (SCFM)	With Compact Transparent Bowl and Guard	
		Automatic Drain Part #	Manual Drain Part #
1/4"	37.0	M16-02A	M16-02M
3/8"	44.7	M16-03A	M16-03M
1/2"	46.1	M16-04A	M16-04M

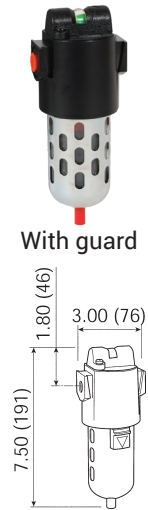

M18-Series Compact Coalescing Filters

Features

- High-efficiency removal of water, oil aerosols, and solid particulate contaminants down to 0.01 mg/m³ with minimum pressure drop
- Modern design and appearance
- Light weight
- High flow capacity
- 1.72 oz. bowl

Specifications

- Maximum operating conditions: 150 PSIG (10.3 bar) and -13°F to 125°F (-25°C to 52°C)

Size	Flow (SCFM)	With Compact Transparent Bowl and Guard	
		Automatic Drain Part #	Manual Drain Part #
1/4"	36	M18-02A	M18-02M
3/8"	36	M18-03A	M18-03M
1/2"	36	M18-04A	M18-04M

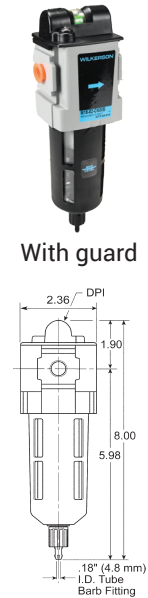

M26-Series Standard Coalescing Filters

Features

- 0.01 micron type C element
- 1.7 oz. bowl
- Can be installed in modular system

Specifications

- Maximum operating conditions: 150 PSIG (10.3 bar) and 32°F to 125°F (0°C to 52°C)

Size	Flow (SCFM)	With Standard Transparent Bowl and Guard	
		Automatic Drain Part #	Manual Drain Part #
1/4"	55.0	---	---
3/8"	65.5	M26-03A	---
1/2"	79.5	M26-04A	M26-04M

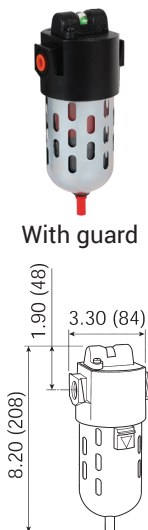

NOTE: SCFM ratings at 150 PSIG inlet pressure.

See pages 30-34 for accessories.

FRLs are designed for air service only, unless otherwise indicated.



With guard

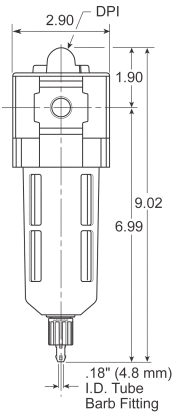

M28-Series Standard Coalescing Filters

Features

- Removes extremely fine oil mists, oil aerosols, and microscopic particles
- A standard airline filter should be installed as a pre-filter when using a coalescing filter
- 0.5 micron type B and 0.003 micron type D elements are optional
- Differential pressure indicator changes from green to red with pressure loss
- High-efficiency removal of water, oil aerosols, and solid particulate



- contaminants down to 0.01 mg/m³ with minimum pressure drop
- Modern design and appearance
- Light weight
- High flow capacity
- 2.87 oz. bowl

Specifications

- Maximum operating conditions: 150 PSIG (10.3 bar) and -13°F to 125°F (-25°C to 52°C)

Size	Flow (SCFM)	Compact Transparent Bowl and Guard	
		Automatic Drain Part #	Manual Drain Part #
3/8"	42	M28-03A	M28-03M
1/2"	42	M28-04A	M28-04M
3/4"	42	M28-06A	M28-06M



With guard

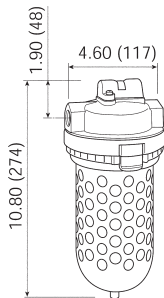

M30-Series Jumbo Coalescing Filters

Features

- 0.01 micron type C element
- 2 oz. bowl

Specifications

- Maximum operating conditions: 150 PSIG (10.3 bar) and 32°F to 125°F (0°C to 52°C)

Size	Flow (SCFM)	Jumbo Transparent Bowl and Guard	
		Automatic Drain Part #	Manual Drain Part #
1/2"	123	M30-04A	
3/4"	173	M30-06A	
1"	203	M30-08A	



M35-0CAMB

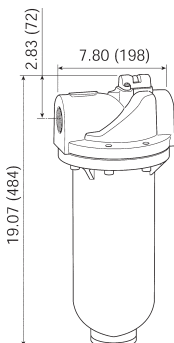

M35-Series Heavy Duty Coalescing Filters

Features

- For removal of extremely fine oil mists, oil aerosols, and microscopic particles
- A standard airline filter should be installed as a pre-filter when using a coalescing filter
- 1.0 micron type B1 and 0.003 micron type D elements are optional
- Differential pressure indicator changes from green to red with pressure loss
- 0.01 micron type C element
- 13.9 oz. bowl
- Differential pressure indicator eliminates the guesswork of element placement



Specification

- Maximum operating conditions: 150 PSIG (10.3 bar) and 32°F to 150°F (0°C to 65.5°C)

Size	Flow (SCFM)	Metal Bowl Automatic Drain Part #
1-1/2"	710	M35-0BAMB
2"	710	M35-0CAMB

NOTE: SCFM ratings at 150 PSIG inlet pressure.

See pages 30-34 for accessories.

FRLs are designed for air service only, unless otherwise indicated.



X03-Series Manual In-Line Desiccant Dryers

Applications

- Manual air dryers are used to remove water vapor from compressed air systems, in applications such as paint spraying, laboratory instruments and small control air systems. Filtration, for absorber type dryers, is important to protect the desiccant bed from contamination. Cleaner incoming air will result in better performance, longer life, and fewer service problems. To regenerate silica gel desiccant, it must be heated to at least **350°F (177°C)** for approximately 3 hours or until color has changed from pink to blue. Allow desiccant to cool to room temperature before pouring back into unit bowl.
- An after-filter should be placed downstream from the desiccant dryer to ensure solid contaminants such as desiccant dust do not migrate downstream



Features

- Will dry up to 4,400 standard cubic feet of air
- Desiccant; good for approximately 440 minutes at maximum continuous air flow before regeneration is required
- Supplied with two bags of silica gel, which changes from blue to pink to indicate the need to replace or regenerate the desiccant. See page 30 for refills.
- Slotted bowl guard for visual detection of color change
- No electrical connection necessary

Specifications

- Provides atmospheric dew point of **-45°F (-43°C)** with dry desiccant at **100 PSI** and **70°F (21°C)**
- Maximum operating conditions:
 - transparent bowl: 150 PSIG (10.3 bar) and **125°F (52°C)**
 - metal bowl: 150 PSIG (10.3 bar) and **150°F (66°C)**



With transparent bowl

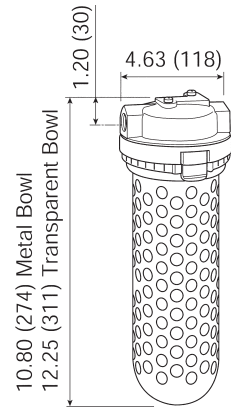

Size	Flow (SCFM)	Transparent Bowl Part #	Metal Bowl Part #
1/4"	10	X03-02	X03-02MB

R21-Series Dial Air Regulators

Applications

- Dial-air regulators feature a transparent, pressure-calibrated, non-rising adjustment dial for quick adjustment of secondary pressure. The full reduced pressure range can be dialed in less than 270° of dial rotation. This feature is particularly advantageous if secondary pressure must be changed frequently. Dial air regulators can be mounted in any position so dial face is always visible. All dial-air units have a slight constant air bleed.

Features

- 0-160 PSI** adjusting range
- Balanced valve design
- Relieving type
- Non-rising pressure adjusting dial
- Piston operated
- Two -1/4" NPT gauge ports standard on models without gauge, one 1/4" NPT gauge port standard on models with gauge - can be used for additional outlet ports.
- Models supplied without gauge use a GC235 gauge

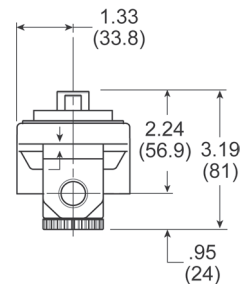

Specifications

- Maximum operating pressure: 300 PSIG (20.7 bar)
- Temperature range: **32°F to 150°F (0°C to 66°C)**

Size	Flow (SCFM)	With Gauge Part #	Without Gauge Part #
1/4"	117	R21-02RG	R21-02R
3/8"	180	R21-03RG	R21-03R
1/2"	195	R21-04RG	R21-04R
3/4"	220	R21-06RG	R21-06R

NOTE: SCFM ratings at 100 PSIG inlet pressure. See pages 30-34 for accessories. FRLs are designed for air service only, unless otherwise indicated.



R16-Series Compact Regulators

Features

- 0-125 PSI adjusting range
- For 0-60 PSI range consult Dixon®
- Self-relieving standard
- Can be installed with the adjusting knob in any position
- To increase regulated pressure, pull adjusting knob up and turn clockwise, to reduce pressure, turn knob counterclockwise
- Two 1/4" NPT gauge ports standard on models without gauge, one 1/4" NPT gauge port standard on models with gauge - can be used for additional outlet ports
- Models supplied without gauge use a GC230 gauge

Specifications

- Maximum operating conditions: 300 PSIG (20.7 bar) and 32°F to 150°F (0°C to 66°C)

Size	Flow (SCFM)	With Gauge Part #	Without Gauge Part #
1/4"	71.5	R16-02RG	R16-02R
3/8"	80.5	R16-03RG	R16-03R
1/2"	88.0	R16-04RG	R16-04R

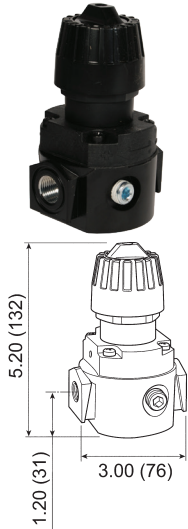

R16-Series High Pressure Compact Regulators

Features

- 0-250 PSI adjusting range
- Self-relieving standard
- Non-rising push/pull locking adjustment knob
- Panel mount nut standard
- Excellent flow characteristics
- Can be installed with the adjusting knob in any position
- Two 1/4" NPT gauge ports standard on models without gauge, one 1/4" NPT gauge port standard on models with gauge - can be used for additional outlet ports
- Models supplied without gauge use a GC240 gauge

Specifications

- Maximum operating conditions: 300 PSIG (20.7 bar) and 32°F to 150°F (0°C to 66°C)

Size	Flow (SCFM)	With Gauge Part #	Without Gauge Part #
1/4"	71.5	R16-02RHG	R16-02RH
3/8"	80.5	R16-03RHG	R16-03RH
1/2"	88.0	R16-04RHG	R16-04RH

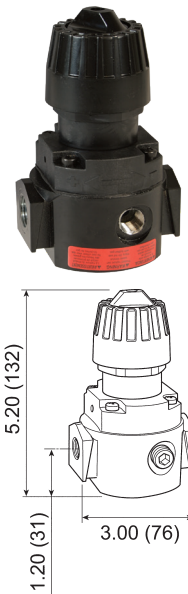

R18-Series Compact Regulators

Features

- 0-125 PSI adjusting range
- Self-relieving standard
- Can be installed with the adjusting knob in any position
- To increase regulated pressure, pull adjusting knob up and turn clockwise, to reduce pressure, turn knob counterclockwise.
- Two 1/4" NPT gauge ports located on the front and rear faces of the body; ports may be used as additional regulated ports or for pressure gauges
- Models supplied without gauge use a GC230 gauge

Specifications

- Maximum operating conditions: 300 PSIG (20.7 bar) and -13°F to 150°F (-25°C to 65.5°C)

Size	Flow (SCFM)	With Gauge Part #	Without Gauge Part #
1/4"	148	R18-02RG	R18-02R
3/8"	165	R18-03RG	R18-03R
1/2"	165	R18-04RG	R18-04R



NOTE: SCFM ratings at 100 PSIG inlet pressure.

See pages 30-34 for accessories.

FRLs are designed for air service only, unless otherwise indicated.

R26-Series Standard Regulators

Features

- 0-125 PSI adjusting range
- Non-rising push/pull locking adjustment knob
- Panel mount nut standard
- Excellent flow characteristics
- Can be installed with the adjusting knob in any position
- To increase regulated pressure, pull adjusting knob up and turn clockwise, to reduce pressure, turn knob counterclockwise
- Two 1/4" NPT gauge ports standard on models without gauge, one 1/4" NPT gauge port standard on models with gauge - can be used for additional outlet ports
- Models supplied without gauge use a GC230 gauge

Specifications

- Maximum operating conditions: 300 PSIG (20.7 bar) and 32°F to 150°F (0°C to 66°C)

Size	Flow (SCFM)	With Gauge Part #	Without Gauge Part #
3/8"	148	R26-03RG	R26-03R
1/2"	185	R26-04RG	R26-04R

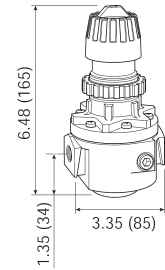

R26-Series High Pressure Standard Regulators

Features

- 0-250 PSI adjusting range
- Self-relieving standard
- Non-rising push/pull locking adjustment knob
- Panel mount nut standard
- Excellent flow characteristics
- Can be installed with the adjusting knob in any position
- Two 1/4" NPT gauge ports standard on models without gauge, one 1/4" NPT gauge port standard on models with gauge can be used for additional outlet ports
- Models supplied without gauge use a GC240 gauge

Specifications

- Maximum operating conditions: 300 PSIG (20.7 bar) and 32°F to 150°F (0°C to 66°C)

Size	Flow (SCFM)	With Gauge Part #	Without Gauge Part #
3/8"	148	R26-03RHG	R26-03RH
1/2"	185	R26-04RHG	R26-04RH

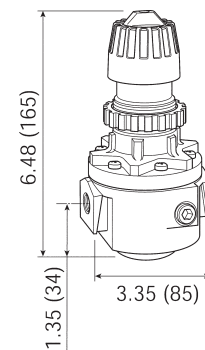

NOTE: SCFM ratings at 100 PSIG inlet pressure.
See pages 30-34 for accessories.

FRLs are designed for air service only, unless otherwise indicated. 

R28-Series Standard Regulators

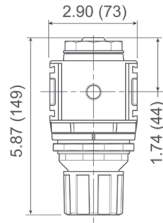

Features

- 0-125 PSI adjusting range
- Self-relieving standard
- Four adjusting pressure ranges available
- To increase regulated pressure, pull adjusting knob up and turn clockwise, to reduce pressure, turn knob counterclockwise.
- Two 1/4" NPT gauge ports located on the front and rear faces of the body; ports may be used as additional regulated ports or for pressure gauges.
- Models supplied without gauge use a GC230 gauge

Specifications

- Maximum operating conditions: 300 PSIG (20.7 bar) and -13°F to 125°F (-25°C to 52°C)

Size	Flow (SCFM)	With Gauge Part #	Without Gauge Part #
3/8"	228	R28-03RG	R28-03R
1/2"	233	R28-04RG	R28-04R
3/4"	233	R28-06RG	R28-06R

R30-Series High Flow Regulators

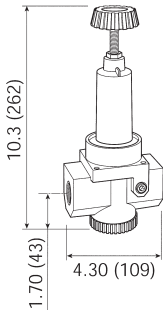

Features

- 0-125 PSI adjusting range
- Self-relieving standard
- Piston operated
- Can be installed with the adjusting knob in any position
- To increase regulated pressure, pull adjusting knob up and turn clockwise, to reduce pressure, turn knob counterclockwise.
- Two 1/4" NPT gauge ports standard on models without gauge, one 1/4" NPT gauge port standard on models with gauge - can be used for additional outlet ports
- Models supplied without gauge use a GC230 gauge

Specifications

- Maximum operating conditions: 300 PSIG (20.7 bar) and 32°F to 150°F (0°C to 66°C)

Size	Flow (SCFM)	With Gauge Part #	Without Gauge Part #
3/4"	481	R30-06RG	R30-06R
1"	500	R30-08RG	R30-08R

R30-Series High Pressure High Flow Regulators

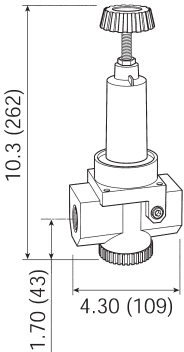

Features

- 0-180 PSI adjusting range
- Self-relieving standard
- Piston operated
- Can be installed with the adjusting knob in any position
- To increase regulated pressure, pull adjusting knob up and turn clockwise, to reduce pressure, turn knob counterclockwise
- Two 1/4" NPT gauge ports standard on models without gauge, one 1/4" NPT gauge port standard on models with gauge - can be used for additional outlet ports
- Models supplied without gauge use a GC240 gauge

Specifications

- Maximum operating conditions: 300 PSIG (20.7 bar) and 32°F to 150°F (0°C to 66°C)

Size	Flow (SCFM)	With Gauge Part #	Without Gauge Part #
3/4"	481	R30-06RHG	R30-06RH
1"	500	R30-08RHG	R30-08RH

NOTE: SCFM ratings at 100 PSIG inlet pressure.

See pages 30-34 for accessories.

FRLs are designed for air service only, unless otherwise indicated.

R40-Series High Flow Regulators

Features

- 0-125 PSI adjusting range
- Self-relieving standard
- Piston operated
- Can be installed with the adjusting knob in any position
- To increase regulated pressure, pull adjusting knob up and turn clockwise, to reduce pressure, turn knob counterclockwise
- Two 1/4" NPT gauge ports standard on models without gauge; one 1/4" NPT gauge port standard on models with gauge - can be used for additional outlet ports
- Models supplied without gauge use a GC230 gauge

Specifications

- Maximum operating conditions:
- 300 PSIG (20.7 bar) and 32°F to 150°F (0°C to 66°C)

Size	Flow (SCFM)	With Gauge Part #	Without Gauge Part #
1-1/2"	1200	R40-0BRG	R40-0BR
2"	1200	R40-0CRG	R40-0CR

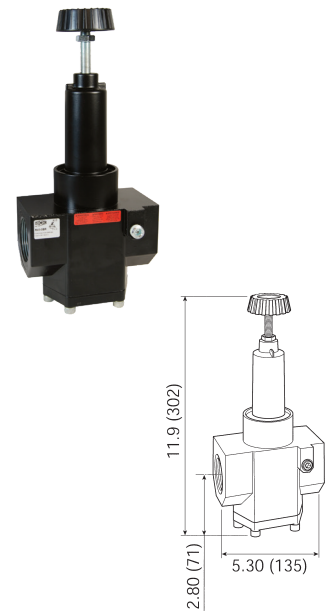

R40-Series High Pressure High Flow Regulators

Features

- 0-180 PSI adjusting range
- Self-relieving standard
- Piston operated
- Can be installed with the adjusting knob in any position
- To increase regulated pressure, pull adjusting knob up and turn clockwise, to reduce pressure, turn knob counterclockwise
- Two 1/4" NPT gauge ports standard on models without gauge; one 1/4" NPT gauge port standard on models with gauge - can be used for additional outlet ports
- Models supplied without gauge use a GC240 gauge

Specifications

- Maximum operating conditions:
- 300 PSIG (20.7 bar) and 32°F to 150°F (0°C to 66°C)

Size	Flow (SCFM)	With Gauge Part #	Without Gauge Part #
1-1/2"	1200	R40-0BRHG	R40-0BRH
2"	1200	R40-0CRHG	R40-0CRH

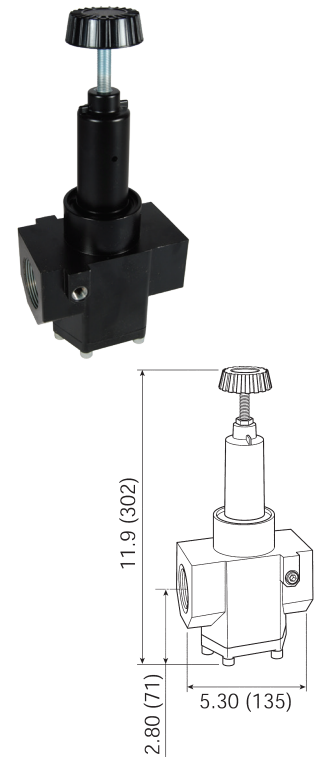

NOTE: SCFM ratings at 100 PSIG inlet pressure.
See pages 30-34 for accessories.
FRLs are designed for air service only, unless otherwise indicated. 

CB6-Series Compact Filter/Regulators

Over-under units are space savers and provide for installation in tight areas. One common inlet/outlet for both filter and regulator saves on piping costs.



With guard

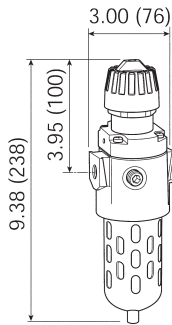

Features

- 0-125 PSIG adjusting range
- 5 micron reusable element
- Self-relieving standard
- Diaphragm operated
- Quick-disconnect bowl guard with integral plastic bowl and safety latch standard
- Two 1/4" gauge ports are provided in either side of the regulator body for installation of a gauge or to use as an additional outlet port, plug unused port(s)
- Supplied with GC230 gauge

Specifications

- Maximum operating conditions:
 - transparent bowl: 150 PSIG (10.3 bar) and 32°F to 125°F (0°C to 52°C)
 - metal bowl: 200 PSIG (13.8 bar) and 32°F to 150°F (0°C to 66°C)

Size	Flow (SCFM)	Transparent Bowl and Guard		Metal Bowl with Sight Glass	
		Automatic Drain Part #	Manual Drain Part #	Automatic Drain Part #	Manual Drain Part #
1/4"	64	CB6-02AG	CB6-02MG	CB6-02AGMB	---
3/8"	70	CB6-03AG	CB6-03MG	CB6-03AGMB	CB6-03MGMB
1/2"	70	CB6-04AG	CB6-04MG	CB6-04AGMB	CB6-04MGMB

B18-Series Compact Filter/Regulators



With metal bowl

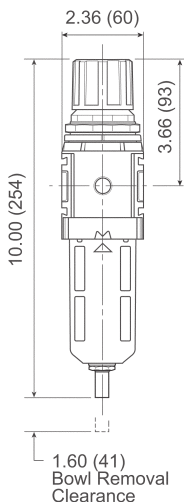

Features

- 5-125 PSIG adjusting range for transparent bowl with guard
- 10-250 PSIG adjusting range for metal bowl with sight glass
- 5 micron element
- 1.72 oz. bowl
- Self-relieving standard
- Spring-loaded diaphragm
- To increase regulated pressure, pull adjusting knob and turn clockwise, to reduce pressure, turn knob counterclockwise, to lock knob, push down
- Two 1/4" gauge ports located on the front and rear faces of the body, these ports may be used as additional regulated ports or for pressure gauges, plug unused port(s)
- Transparent bowl supplied with GC230 gauge
- Metal bowl supplied with GC240 gauge

Specifications

- Maximum operating conditions:
 - transparent bowl: 150 PSIG (10.3 bar) and -13°F to 125°F (-25°C to 52°C)
 - metal bowl: 250 PSIG (17.2 bar) and -13°F to 150°F (-25°C to 66°C)

Size	Flow (SCFM)	Transparent Bowl and Guard		Metal Bowl with Sight Glass	
		Automatic Drain Part #	Manual Drain Part #	Automatic Drain Part #	Manual Drain Part #
1/4"	148	B18-02AG	B18-02MG	B18-02AGMB	B18-02MGMB
3/8"	158	B18-03AG	B18-03MG	B18-03AGMB	B18-03MGMB
1/2"	164	B18-04AG	B18-04MG	B18-04AGMB	B18-04MGMB

NOTE: SCFM ratings at 100 PSIG inlet pressure.

See pages 30-34 for accessories.

FRLs are designed for air service only, unless otherwise indicated.

B28-Series Standard Filters/Regulators

Features

- 5-125 PSIG adjusting range for transparent bowl with guard
- 10-250 PSIG adjusting range for metal bowl with sight glass
- 5 micron element
- 2.87 oz. bowl
- Self-relieving standard
- Spring-loaded diaphragm
- To increase regulated pressure, pull adjusting knob and turn clockwise, to reduce pressure, turn knob counterclockwise, to lock knob, push down
- Two 1/4" gauge ports located on the front and rear faces of the body. These ports may be used as additional regulated ports or for pressure gauges. Plug unused port(s).
- Transparent bowl supplied with GC230 gauge
- Metal bowl supplied with GC240 gauge

Specifications

- Maximum operating conditions:
 - transparent bowl: 150 PSIG (10.3 bar) and -13°F to 125°F (-25°C to 52°C)
 - metal bowl: 250 PSIG (17.2 bar) and -13°F to 150°F (-25°C to 66°C)

Size	Flow (SCFM)	Transparent Bowl and Guard		Metal Bowl with Sight Glass	
		Automatic Drain Part #	Manual Drain Part #	Automatic Drain Part #	Manual Drain Part #
3/8"	200	B28-03AG	B28-03MG	B28-03AGMB	B28-03MGMB
1/2"	200	B28-04AG	B28-04MG	B28-04AGMB	B28-04MGMB
3/4"	235	B28-06AG	B28-06MG	B28-06AGMB	B28-06MGMB

NOTE: See pages 30-34 for accessories.
SCFM ratings at 100 PSIG inlet pressure.



With transparent bowl

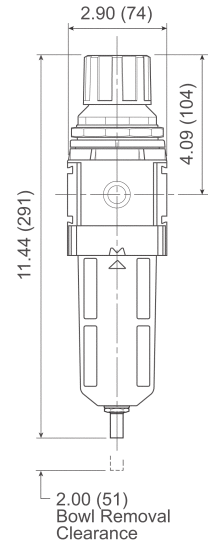

L16-Series EconOmist® Compact Lubricators

Designed so that all the oil flow observed in the sight dome is broken into a mist and delivered via the airflow to the application. The oil in the bowl can be filled or replenished without interrupting airflow or bleeding pressure from the system. Once the oil-fill cap is removed, the bowl is depressurized and isolated from line pressure, and the bowl itself can then be removed for faster refill, if desired. The bowl can be filled right to the top.

Features

- 5 oz. bowl
- Full view sight dome
- Fill under pressure design

Specifications

- Maximum operating conditions:
 - transparent bowl: 150 PSIG (10.3 bar) and 32°F to 125°F (0°C to 52°C)
 - metal bowl: 200 PSIG (13.8 bar) and 32°F to 150°F (0°C to 66°C)

Size	Flow (SCFM)	Transparent Bowl Part #	Metal Bowl Part #
1/4"	36.1	L16-02A	L16-02AMB
3/8"	58.5	L16-03A	L16-03AMB
1/2"	64.0	L16-04A	L16-04AMB

NOTE: SCFM ratings at 150 PSIG inlet pressure.
See pages 30-34 for accessories.
See page 34 for air tool lubricant.
FRLs are designed for air service only, unless otherwise indicated.



Transparent bowl with guard

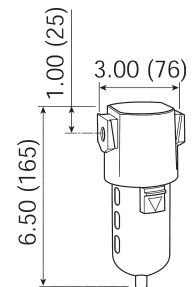

Flow Guide®

The elastomer disc-shaped device is located in the throat of all Wilkerson lubricators and automatically maintains a constant ratio of oil flow to airflow regardless of changing rates of airflow. This allows one lubricator to serve several pneumatic components operating together or intermittently.

Type of oil to use

For all Wilkerson lubricators, use any petroleum-base, non-detergent lightweight oil (SAE 10/150SSU) which will readily break up into a mist, i.e., Mobil DTE light or comparable oil. Do not use synthetic oil or any oils containing additives or solvents. See page 34 for air tool lubricants.

L18-Series EconOmist® Compact Lubricators



With metal bowl

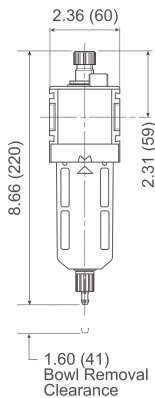

Features

- 4 oz. bowl
- Manual drain
- High flow capacity
- Can be filled under pressure
- To adjust and set oil delivery rate the unit must be pressurized, and air must be flowing through the unit. Turn the sight dome, located on the top of the unit, counterclockwise to initiate oil delivery. The rate of oil delivery depends on air flow rate. If flow increases or decreases, the oil delivery rate will increase or decrease proportionally. Turning the sight dome clockwise will stop all oil delivery

Specifications

- Maximum operating conditions:
 - transparent bowl: 150 PSIG (10.3 bar) and 14°F to 125°F (-10°C to 52°C)
 - metal bowl: 250 PSIG (17.2 bar) and 14°F to 150°F (-10°C to 65.5°C)

Size	Flow (SCFM)	Transparent Bowl Part #	Metal Bowl Part #
1/4"	88	L18-02A	L18-02AMB
3/8"	90	L18-03A	L18-03AMB
1/2"	96	L18-04A	L18-04AMB

L26-Series EconOmist® Standard Lubricators



With metal bowl

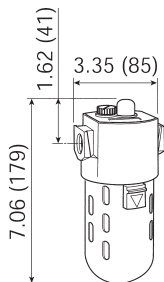

Features

- 10 oz. bowl
- Adjustable oil feed
- Can be filled under pressure
- Quick-disconnect metal bowl guard with integral safety latch
- Siphon tube filter provides clean lubricant downstream
- The rate of oil delivery may be controlled by turning the adjusting screw counterclockwise for more and clockwise for less oil delivery. If flow increases or decreases, the oil delivery rate will increase or decrease proportionally

Specifications

- Maximum operating conditions:
 - transparent bowl: 150 PSIG (10.3 bar) and 32°F to 125°F (0°C to 52°C)
 - metal bowl: 200 PSIG (13.8 bar) and 32°F to 150°F (0°C to 66°C)

Size	Flow (SCFM)	Transparent Bowl Part #	Metal Bowl ¹ Part #
3/8"	60	L26-03A	L26-03AMB
1/2"	128	L26-04A	L26-04AMB

¹ Metal bowl has sight gauge with brass petcock drain

NOTE: SCFM ratings at 150 PSIG inlet pressure.
See pages 30-34 for accessories.
See page 34 for air tool lubricant.

FRLs are designed for air service only, unless otherwise indicated. 

L28 EconOmist® Standard Lubricators

Features

- 6 oz. bowl
- Manual drain
- High flow capacity
- Can be filled under pressure
- To adjust and set oil delivery rate the unit must be pressurized and air must be flowing through the unit. Turn the sight dome, located on the top of the unit, counterclockwise to initiate oil delivery. If flow increases or decreases, the oil delivery rate will increase or decrease proportionally. Turning the sight dome clockwise will stop all oil delivery

Specifications

- Maximum operating conditions:
 - transparent bowl: 150 PSIG (10.3 bar) and 14°F to 125°F (-10°C to 52°C)
 - metal bowl: 250 PSIG (17.2 bar) and 14°F to 150°F (-10°C to 65.5°C)

Size	Flow (SCFM)	Transparent Bowl Part #	Metal Bowl Part #
3/8"	110	L28-03A	L28-03AMB
1/2"	110	L28-04A	L28-04AMB
3/4"	150	L28-06A	L28-06AMB

NOTE: SCFM ratings at 150 PSIG inlet pressure.



With metal bowl

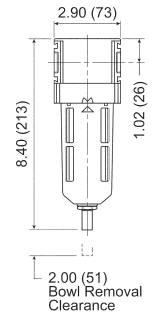

L30 EconOmist® Standard Lubricators

Features

- 26 oz. bowl
- Transparent bowl: no drain
metal bowl: manual brass petcock drain
- Can be filled under pressure
- The rate of oil delivery may be controlled by turning the adjusting screw counterclockwise for more and clockwise for less oil delivery. The oil delivery rate will change automatically to deliver more oil during higher air flows and less oil for air flows lower than the one at which the setting was made

Specifications

- Maximum operating conditions:
 - transparent bowl: 150 PSIG (10.3 bar) and 32°F to 125°F (0°C to 52°C)
 - metal bowl: 200 PSIG (13.8 bar) and 32°F to 150°F (0°C to 66°C)

Size	Flow (SCFM)	Transparent Bowl Part #	Metal Bowl Part #
3/4"	196	L30-06A	L30-06AMB
1"	374	L30-08A	L30-08AMB

NOTE: SCFM ratings at 120 PSIG inlet pressure.

NOTE: SCFM ratings at 150 PSIG inlet pressure.

See pages 30-34 for accessories.

See page 34 for air tool lubricant.

FRLs are designed for air service only, unless otherwise indicated.



With metal bowl

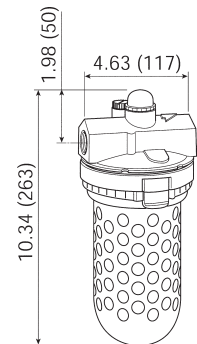



Transparent bowl with guard

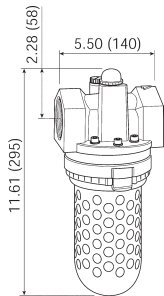

Illustration represents L40 series

L40 & L50-Series EconOmist® Standard Lubricators

Features

- 26 oz. bowl
- Transparent bowl: solid bottom metal bowl: manual drain with sight glass
- Full view sight dome
- Adjustable oil feed
- Can be filled under pressure
- Quick-disconnect clamp ring for easy bowl removal
- The rate of oil delivery may be controlled by turning the adjusting screw counterclockwise for more and clockwise for less oil delivery. The oil delivery rate will change automatically to deliver more oil during higher air flows and less oil for air flows lower than the one at which the setting was made

Specifications

- Maximum operating conditions:
 - transparent bowl: 150 PSIG (10.3 bar) and 32°F to 125°F (0°C to 52°C)
 - metal bowl: 200 PSIG (13.8 bar) and 32°F to 150°F (0°C to 66°C)

Size	Flow (SCFM)	Transparent Bowl Part #	Metal Bowl with Sight Glass Part #
1-1/2"	927	L40-0BA	L40-0BAMB
2"	1186	L50-0CA	L50-0CAMB

NOTE: See pages 30-34 for accessories.

See page 6 for air tool lubricant.

FRLs are designed for air service only, unless otherwise indicated.

SCFM ratings at 120 PSIG inlet pressure.

C16-Series Compact Combination Units

Features

- Included components:
 - (2) modular sleeves
 - (2) mounting brackets (sleeve and bracket)
 - (2) end blocks

Filter series F16:

- 5 micron element
- 2.7 oz. bowl

Regulator series R16:

- 0-125 PSI adjusting range
- Self-relieving
- Supplied with a GC230 gauge

Lubricator series L16:

- 5 oz. bowl
- Adjustable oil feed
- Full view sight dome



Transparent bowl with guard

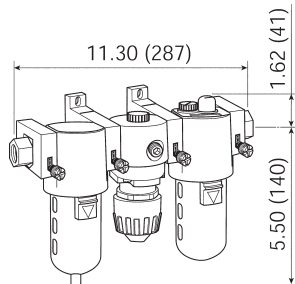

Specifications

- Maximum operating conditions:
 - transparent bowl: 150 PSIG (10.3 bar) and 32°F to 125°F (0°C to 52°C)
 - metal bowl: 200 PSIG (13.8 bar) and 32°F to 175°F (0°C to 80°C)

Size	Flow (SCFM)	Transparent Bowl and Guard		Metal Bowl with Sight Glass	
		Automatic Drain Part #	Manual Drain Part #	Automatic Drain Part #	Manual Drain Part #
1/4"	36.1	C16-02A	C16-02M	C16-02AMB	C16-02MMB
3/8"	58.5	C16-03A	C16-03M	---	C16-03MMB
1/2"	64.0	C16-04A	C16-04M	C16-04AMB	C16-04MMB

NOTE: SCFM ratings at 150 PSIG inlet pressure.

FRLs are designed for air service only, unless otherwise indicated.

C18-Series Compact Combination Units

Features

- Included components:
 - (2) end blocks
 - (2) mounting brackets with joiner set and port O-ring

Filter series F18:

- 5 micron element
- 1.72 oz. bowl

Regulator series R18:

- **0-125 PSI** adjusting range
- Self-relieving
- Supplied with a GC230 gauge

Lubricator series L18:

- 4 oz. bowl
- Adjustable oil feed
- Full view sight dome

Specifications

- Maximum operating conditions:
 - transparent bowl: 150 PSIG (10.3 bar) and -13°F to 125°F (-25°C to 52°C)
 - metal bowl: 250 PSIG (17.2 bar) and -13°F to 150°F (-25°C to 66°C)

Size	Flow (SCFM)	Transparent Bowl and Guard		Metal Bowl with Sight Glass	
		Automatic Drain Part #	Manual Drain Part #	Automatic Drain Part #	Manual Drain Part #
1/4"	42	C18-02A	C18-02M	C18-02AMB	C18-02MMB
3/8"	68	C18-03A	C18-03M	C18-03AMB	C18-03MMB
1/2"	85	C18-04A	C18-04M	C18-04AMB	C18-04MMB



With metal bowl

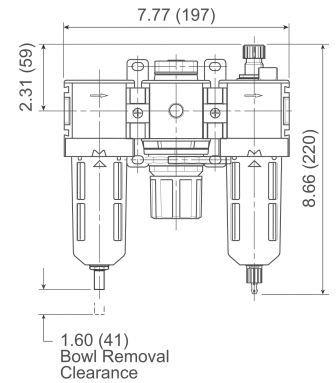

C26-Series Standard Combination Units

Features

- Included components:
 - (2) modular sleeves
 - (2) mounting brackets (sleeve and bracket)
 - (2) end blocks

Filter series F26:

- 5 micron element
- 3.2 oz. bowl

Regulator series R26:

- **0-125 PSI** adjusting range
- Self-relieving
- Supplied with a GC230 gauge

Lubricator series L26:

- 10 oz. bowl
- Adjustable oil feed
- Full view sight dome

Specifications

- Maximum operating conditions:
 - transparent bowl: 150 PSIG (10.3 bar) and 32°F to 125°F (0°C to 52°C)
 - metal bowl: 200 PSIG (13.8 bar) and 32°F to 175°F (0°C to 80°C)

Size	Flow (SCFM)	Transparent Bowl and Guard		Metal Bowl	
		Automatic Drain Part #	Manual Drain Part #	Automatic Drain Part #	Manual Drain Part #
3/8"	60	C26-03A	C26-03M	C26-03AMB	C26-03MMB
1/2"	128	C26-04A	C26-04M	C26-04AMB	C26-04MMB



With metal bowl

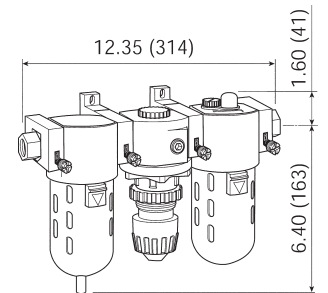

NOTE: SCFM ratings at 150 PSIG inlet pressure.

FRLs are designed for air service only, unless otherwise indicated.

C28-Series Standard Combination Units



With metal bowl

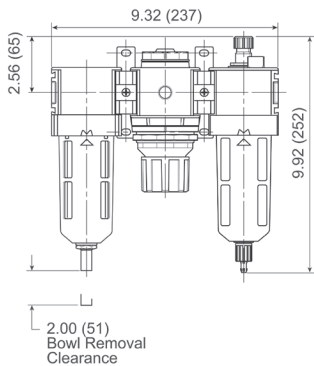

Features

- Modern design and appearance
- Quick disconnect bowl / bowl guard
- Included components:
 - (2) end blocks
 - (2) mounting brackets with joiner set and port O-ring

Filter series F28:

- 5 micron element
- 2.87 oz. bowl

Regulator series R28:

- **0-125 PSI** adjusting range
- Self-relieving
- Supplied with a GC230 gauge

Lubricator series L28:

- 6 oz. bowl
- Adjustable oil feed
- Full view sight dome

Specifications

- Maximum operating conditions:
 - transparent bowl: 150 PSIG (10.3 bar) and **-13°F to 125°F (-25°C to 52°C)**
 - metal bowl: 250 PSIG (17.2 bar) and **-13°F to 150°F (-25°C to 66°C)**

Size	Flow (SCFM)	Transparent Bowl and Guard		Metal Bowl	
		Automatic Drain Part #	Manual Drain Part #	Automatic Drain Part #	Manual Drain Part #
3/8"	90	C28-03A	C28-03M	C28-03AMB	C28-03MMB
1/2"	90	C28-04A	C28-04M	C28-04AMB	C28-04MMB
3/4"	110	C28-06A	C28-06M	C28-06AMB	C28-06MMB

NOTE: SCFM ratings given at 150 PSIG inlet pressure.

C31-Series Jumbo Combination Units

Features

- High flow capacity
- Large bowl reservoir
- Included components:
 - (2) brass hex nipples

Filter series F30:

- 5 micron element
- 2 oz. bowl

Regulator series R30:

- **0-125 PSI** adjusting range
- Self-relieving
- Supplied with a GC230 gauge

Lubricator series L30:

- 26 oz. bowl
- Adjustable oil feed
- Full view sight dome



With metal bowl

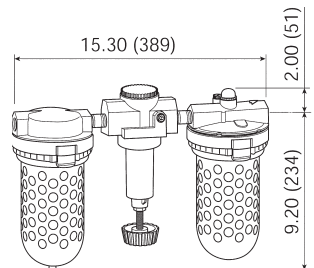

Specifications

- Maximum operating conditions:
 - transparent bowl: 150 PSIG (10.3 bar) and **32°F to 125°F (0°C to 52°C)**
 - metal bowl: 200 PSIG (13.8 bar) and **32°F to 175°F (0°C to 80°C)**

Size	Flow (SCFM)	Transparent Bowl and Guard		Metal Bowl with Sight Glass	
		Automatic Drain Part #	Manual Drain Part #	Automatic Drain Part #	Manual Drain Part #
3/4"	374	C31-06A	C31-06M	C31-06AMB	C31-06MMB
1"	374	C31-08A	C31-08M	C31-08AMB	C31-08MMB

NOTE: SCFM ratings at 120 PSIG inlet pressure.

FRLs are designed for air service only, unless otherwise indicated.

D18-Series Combination Units

Features

- Light weight, ready-to-mount assembly comes standard with pressure gauge and modular T-bracket/joiner assembly
 - Components integrated into single unit
 - Modern design and appearance
 - Quick disconnect bowl/bowl guard
 - 5 micron element
 - 4 oz. bowl/lubricator
- Regulator:
- **0-125 PSI** adjusting range
 - Self-relieving
 - Supplied with gauge
 - 1.72 oz. bowl/filter

Specifications

- Maximum operating conditions:
 - transparent bowl: 150 PSIG (10.3 bar) and 13°F to 125°F (-25°C to 52°C)
 - metal bowl: 250 PSIG (17.2 bar) and -13°F to 150°F (-25°C to 66°C)

Size	Flow (SCFM)	Transparent Bowl and Guard	Metal Bowl / Sight Gauge
		Manual Drain Part #	Manual Drain Part #
1/2"	90	D18-04M	D18-04MMB

NOTE: SCFM ratings at 150 PSIG inlet pressure.



With transparent bowl and guard

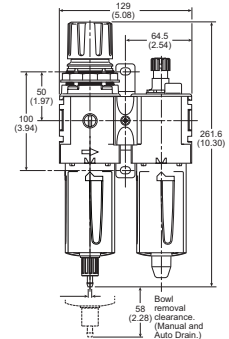

D28-Series Combination Units

Features

- Light weight, ready-to-mount assembly comes standard with pressure gauge and modular T-bracket/joiner assembly
 - Components integrated into single unit
 - Modern design and appearance
 - Quick disconnect bowl/bowl guard
 - 5 micron element
 - 6 oz. bowl/lubricator
- Regulator:
- **0-125 PSI** adjusting range
 - Self-relieving
 - Supplied with gauge
 - 2.87 oz. bowl/filter

Specifications

- Maximum operating conditions:
 - 250 PSIG (17.2 bar) and -13°F to 125°F (-25°C to 52°C)

Size	Flow (SCFM)	Metal Bowl / Sight Gauge
		Manual Drain Part #
1/2"	150	D28-04MMB
3/4"	150	D28-06MMB

NOTE: SCFM ratings at 150 PSIG inlet pressure.
 FRLs are designed for air service only, unless otherwise indicated.



With metal bowl

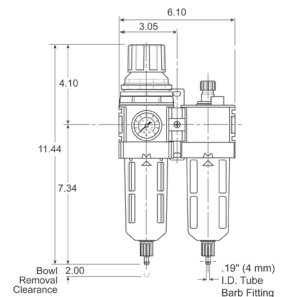

C31-Series Combination Unit with Protective Frame

Application

- Provides downstream air preparation with protection and convenience

Features

- Includes components:
 - C31-08AMB 1" FRL with metal bowls and auto drain filter
 - BBLV100 1" brass ball valve and AM12 Air King® on inlet port
 - BBV100DTW 3-way ball valve installed between regulator and lubricator provides option for non-lubricated air
- Heavy duty frame protects air prep components



Specifications

- Operating:
 - maximum pressure: 250 PSIG
 - temperature range: 40°F to 150°F (4°C to 66°C)
 - flow: 320 SCFM

Size	Part #
1"	C31-08FRAME

F23-Series Exhaust Muffler

Features

- The contaminants in the exhaust flow are mechanically separated and twice filtered to 5 micron levels, the clean, muffled exhaust flows out of the unit under the metal hood on top
- Removes oily aerosols from exhaust flows
- One inlet port
- 5 micron element
- Quick disconnect clamp ring for easy bowl removal
- Manual drain

Specifications

- Operating:
 - maximum pressure: 150 PSIG (10.3 bar)
 - temperature range: 32°F to 125°F (0°C to 52°C)

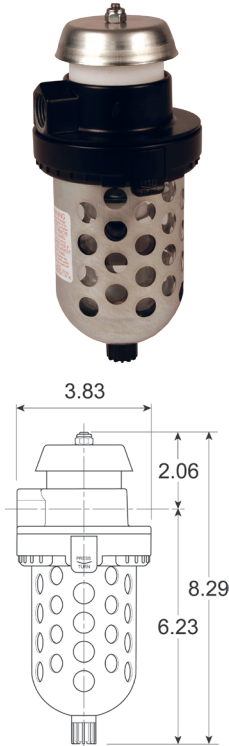

Size	Flow @ 90 PSI	Transparent Bowl with Guard Part #
1/2"	240 SCFM	F23-04M

NOTE: FRLs are designed for air service only, unless otherwise indicated. 

X02-Series Automatic Drains

As liquid contaminants collect in the bowl, they raise a closed-cell cellular float. When the liquid level reaches a given point, the float triggers a mechanism which pilots line pressure against a large area piston or diaphragm which snaps open the drain valve. The contaminants are discharged from the drain orifice at line pressure. As the liquid level falls, the pilot valve closes, line pressure against the piston/diaphragm returns to atmosphere and the drain valve snaps closed.

Features

- 5 oz. bowl
- Fully automatic, float operated
- Full 1/2" NPT drain inlet
- Quick-disconnect clamp ring for easy bowl removal when servicing
- No electrical connections
- Easy installation

Specifications

- Maximum operating conditions:
 - transparent bowl: 150 PSIG (10.3 bar) and 32°F to 125°F (0°C to 52°C)
 - metal bowl: 200 PSIG (13.8 bar) and 32°F to 150°F (0°C to 66°C)



With metal bowl

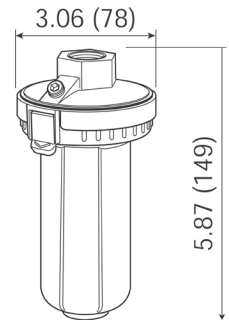

Size	Transparent Bowl Part #	Metal Bowl Part #
1/2"	X02-04	X02-04MB

Lockout Valves

Application

- Lockout valves are installed in pneumatic drop legs or individual pneumatic control lines, in accordance with OSHA procedures, lockout valves are used during maintenance and service procedures of pneumatically (air) operated equipment

Features

- Used to comply with OSHA 29 CFR part 1910
- Built in port for pressure verification to meet ANSI B11 and Pmm155 requirements
- Inline or surface mountable
- Yellow cast aluminum body with red handle

Specifications

- Pressure range: 15-300 PSI
- Temperature range: 40°F to 175°F (4°C to 79°C)



Port In/Out	Port Exhaust	Part #
1/2"	3/4"	LV4N6D
3/4"	3/4"	LV6N6D
3/4"	1-1/4"	LV6NAD
1"	1-1/4"	LV8NAD

NOTE: FRLs are designed for air service only, unless otherwise indicated.

Filter Elements



FRP-95-115

Used On	Description	Part #
F03, C03	5 micron element	PS403
B08, C08, F08		FRP-96-729
F16		FRP-95-160
F18		FRP-96-639
F26		FRP-95-115
F28		FRP-96-653
F30		FRP-95-209
F35		FRP-95-505

Coalescing Filter Elements



MTP-95-548

Used On	Description	Part #
M16, M26, M30	type B element (0.5 micron)	MSP-95-989
M16	type C element (0.01 micron)	MTP-95-548
M26	type C element (0.01 micron)	MTP-95-549
M30	type C element (0.01 micron)	MTP-95-551
M35	type C element (0.01 micron)	MTP-95-502

Desiccant Dryer Gel Refill



Used On	Description	Part #
X03	2 bags of silica gel refill	DRP-14-10B/002

Filter Bowls with Drain



FRP-95-015

Used On	Description	Part #
F08, C08, B08	plastic bowl with guard and manual drain	GRP-96-712
F16, M16	plastic bowl and metal bowl guard with flex tip drain	FRP-95-014
	plastic bowl and metal bowl guard with auto drain	FRP-95-015
	plastic bowl with manual drain	FRP-95-017
	metal bowl with sight glass and manual drain	GRP-95-133
	metal bowl with auto drain	FRP-95-950
F18	plastic bowl and bowl guard with manual drain	GRP-96-634
	plastic bowl and bowl guard with auto drain	GRP-96-635
	metal bowl with sight glass and manual drain	GRP-96-636
F26, M26	plastic bowl and metal bowl guard with flex tip drain	GRP-95-935
	plastic bowl and metal bowl guard with auto drain	GRP-95-948
	metal bowl with sight glass and manual drain	GRP-95-931
	metal bowl with auto drain	GRP-95-960
F28	plastic bowl, bowl guard, manual drain	GRP-96-642
	metal bowl, with sight glass, manual drain	GRP-96-644
F30, M30	plastic bowl and metal bowl guard with manual drain	FRP-95-832
	plastic bowl and metal bowl guard with auto drain	FRP-95-775
	plastic bowl with flex tip drain	FRP-96-315
	metal bowl with sight glass and manual drain	GRP-95-676
	metal bowl with auto drain	GRP-95-970

Filter Drains

Used On	Description	Part #
B18, CB6, F16, F18, F26, F28, F30, F35, M16, M26, M30, M32, M35	automatic drain with fluorocarbon seal	GRP-95-981
F16, F18, F26, F28, F30, M16, M26, M30	automatic float drain with a nitrile seal	GRP-95-973
F16, F18, F26, F28, F30, F35, M16, M26, M30, M35	manual override drain	GRP-96-001
F16, F26, F30, M16, M26, M30	manual petcock drain for use with metal bowl units	GRP-95-182
F16, F26, F30, M16, M26, M30	manual flex tip drain	FRP-95-610
F18, F28	manual drain	GRP-96-685



GRP-96-001

Sight Glass Kit

Used On	Description	Part #
M16, M26	sight glass kit for metal bowls	GRP-95-079



Differential Pressure Indicators

Features

- Used to replace damaged indicators on filters and modular coalescing filters
- Pressure loss changes color of indicator window from green to red

Used On	Description	Part #
M16, M26, M30, M32	indicator	DP2-01-000
F35, M35	indicator	DP2-01-001
M18, M28	indicator	DP8-01-000



DP2-01-000

Ring Style Tamper Resistant Kits

Used On	Description	Part #
C08, B08, R08	ring style tamper resistant kit	RPA-96-735
R16, R26		RPA-95-006
R18		RRP-96-671
R28		RRP-96-672



RPA-95-006

Regulator Repair Kits



RRP-95-952

Used On	Description	Part #
R16	self-relieving repair kit	RRP-95-131
R26	self-relieving repair kit	RRP-95-952

Lubricator Bowls and Bowl Guards

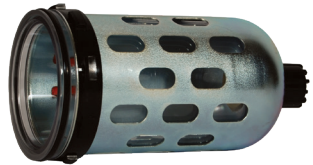

GRP-95-019

Used On	Description	Part #
C08, L08	plastic bowl with guard and manual drain	LRP-96-736
L16	metal bowl with sight glass and manual drain	GRP-95-133
	plastic bowl with guard and manual drain	GRP-95-019
	plastic bowl with no drain	LRP-96-937
L18	metal bowl with sight glass, manual drain	GRP-96-636
	plastic bowl with guard and manual drain	LRP-96-701
L26	metal bowl with sight glass and manual drain	GRP-95-931
	plastic bowl with no drain	LRP-96-938
L28	metal bowl with sight glass, manual drain	GRP-96-644
	plastic bowl with guard and manual drain	LRP-96-702
L30, L40	metal bowl with sight glass and manual drain	GRP-95-676
L30, L40, L50	plastic bowl with no drain	LRP-96-940

Sight Domes and Fill Plugs



LRP-95-249

Used On	Description	Part #
C08, L08, L16, L26	sight dome kit: dome and O-ring	LRP-95-239
C08, L08	fill plug kit: fill plug and O-ring	LRP-96-730
L16, L26, L30	fill plug kit: fill plug and O-ring	LRP-95-253
L18, L28	sight dome assembly (new style)	LRP-96-310
L30, L40, L50	sight dome kit: dome and O-ring	LRP-95-249
L40, L50	fill plug kit: fill plug and O-ring	LRP-95-250

Modular Shut-Off Valves

Application

- Useful for isolating and depressurizing a downstream unit requiring maintenance or replacement

Features

- Can be installed immediately upstream of a single unit or combination of units
- Secure to the unit with a modular sleeve or modular sleeve wall mounting bracket
- Ball-type valve operates with a 1/4 turn from open to shut position
- Can be locked in the open position
- Left-to-right flow



GPA-95-098

Used On	Description	Part #
F16, F26, R16, B26, L16, L26	1/4" NPT safety shut-off valve	GPA-95-096
	3/8" NPT safety shut-off valve	GPA-95-097
	1/2" NPT safety shut-off valve	GPA-95-098

Modular Blocks

Features

Manifold Block

- Flexible installation can be installed after the filter or regulator, providing three additional 1/4" NPT tapped auxiliary ports
- 1/2" inlet/outlet ports non-tapped
- 1-17/32" width

End Block

- When used with the modular sleeve, end blocks allow a single unit or a combination of units to be piped into the air system in the modular mode
- Allows ease of unit servicing or replacement without disturbing the air line connections

Used On	Description	Part #
C16, C26, F16, M16, F26, M26, R16, R26, L16, L26	manifold block, three 1/4" NPT auxiliary ports	GPA-95-919
	end block, 1/4" NPT	GPA-95-223
	end block, 3/8" NPT	GPA-95-224
	end block, 1/2" NPT	GPA-95-225
C18, F18, F28, R18, R28, L18, L28	end block, 1/4" NPT	GPA-96-610
	end block, 3/8" NPT	GPA-96-611
	end block, 1/2" NPT	GPA-96-612
	end block, 3/4" NPT	GPA-96-613



GPA-95-919



GPA-95-223



GPA-96-610

Modular Pipe Adapters

Features

- When used with the modular sleeve, adapter inserts allow a single unit or a combination of units to be piped into the air system in the modular mode
- Allows ease of unit servicing or replacement without disturbing the air line connections
- Set includes (2) blocks

Used On	Description	Part #
F16, M16, F26, M26, R16, R26, L16, L26	1/4" NPT	GPA-95-035
	3/8" NPT	GPA-95-036
	1/2" NPT	GPA-95-037



GPA-95-037

Modular Sleeve

Features

- Design easily and quickly connects one or more units and accessories together without pipe nipples
- Hand tightening the threaded pin provides a tight seal between the units

Used On	Description	Part #
C16, C26, F16, F26, R16, R26, L16, L26	modular sleeve	GPA-95-292



Modular Sleeve with T Bracket

Features

- Designed to mount a single unit or combination of units directly to the wall
- Sleeve and mounting bracket can be ordered assembled, or just the mounting bracket alone for use on existing modular sleeves

Used On	Description	Part #
C16, C26, F16, F26, R16, R26, L16, L26	bracket	GPA-95-968
	sleeve and bracket	GPA-95-969



GPA-95-969

Mounting Brackets and Joiner Sets



GPA-96-737

Used On Filter/ Regulator/ Lubricator Series	Description	Part #
BB3, RB3	mounting bracket (type L) and nut	GRP-95-747
F03	mounting bracket	PS417B
B08, C08, F08, R08	mounting bracket (type T) with joiner set and port O-ring	GPA-96-737
	mounting bracket (type C)	GPA-97-010
	joiner set and port O-ring	GPA-96-738
B08, R08	mounting bracket (type L)	GRP-96-739
F16, M16	mounting bracket (type L)	GPA-95-016
R16	mounting bracket (type L) and nut	GPA-95-011
R16, R21, R26, R30, R40	wall mount bracket with 1/4" NPT gauge port adapter	RRP-95-590
F18	body mounting bracket (type L)	GPA-96-604
	bonnet mounting bracket (type L)	GPA-96-606
C18, F18, F28	mounting bracket (type T)	GPA-96-602
	mounting bracket (type T) with joiner set and port O-ring	GPA-96-603
F26, M26	mounting bracket (type L)	GPA-95-946
F28	body mounting bracket (type L)	GPA-96-605
	mounting bracket (type L)	GPA-96-607
F30	wall mount, U-bolt pipe clamp	GRP-95-734

Air Tool Lubricants

Application

- High-grade lubricant prolongs the service life of air tools, cylinders, and accessories

- Prohibits rust and removes moisture as it lubricates
- Non-corrosive, non-reactive, non-detergent, and does not decompose
- Easy pour spout helps prevent costly spills
- Also for use with the in-line lubricators

Features

- #10 weight lubricant
- Compound is superior in performance to ordinary lubricants



Pint



Gallon

Size	Part #	Optional Qty
1 pint	DATL016	12
1 gallon	DATL128	4

Cross Reference

Dixon	Wilkerson	Dixon	Wilkerson	Dixon	Wilkerson
B08-01AG	B08-01-FRG0	C08-01MMB	C08-01-LLG0	C31-06AMB	C31-06-FG0
B08-01MG	B08-01-FKG0	C08-02AMB	C08-02-LSG0	C31-06MMB	C31-06-G0
B08-01AGMB	B08-01-LSG0	C08-02MMB	C08-02-LLG0	C31-08A	C31-08-F00
B08-01MGMB	B08-01-LLG0	C16-02A	C16-02-F00	C31-08M	C31-08-000
B08-02AG	B08-02-FRG0	C16-02M	C16-02-000	C31-08AMB	C31-08-FG0
B08-02MG	B08-02-FKG0	C16-02AMB	C16-02-FG0	C31-08MMB	C31-08-G00
B08-02AGMB	B08-02-LSG0	C16-02MMB	C16-02-G00	CB6-02AG	CB6-02-F00
B08-02MGMB	B08-02-LLG0	C16-03A	C16-03-F00	CB6-02AGMB	CB6-02-FG0
B18-02A	B18-02-FGG0	C16-03M	C16-03-000	CB6-02MG	CB6-02-000
B18-03A	B18-03-FGG0	C16-03AMB	C16-03-FG0	CB6-02MGMB	CB6-02-G00
B18-04A	B18-04-FGG0	C16-03MMB	C16-03-G00	CB6-02AMB	CB6-02-FM0
B18-02M	B18-02-FK00	C16-04A	C16-04-F00	CB6-02MMB	CB6-02-G00
B18-03M	B18-03-FK00	C16-04M	C16-04-000	CB6-03AG	CB6-03-F00
B18-04M	B18-04-FK00	C16-04AMB	C16-04-FG0	CB6-03AGMB	CB6-03-FG0
B18-02AMB	B18-02-GH00	C16-04MMB	C16-04-G00	CB6-03MG	CB6-03-000
B18-03AMB	B18-03-GH00	C18-02A	C18-02-FGG0	CB6-03AMB	CB6-03-FM0
B18-04AMB	B18-04-GH00	C18-03A	C18-03-FGG0	CB6-03MGMB	CB6-03-G00
B18-02MMB	B18-02-GL00	C18-04A	C18-04-FGG0	CB6-03MMB	CB6-03-G00
B18-03MMB	B18-03-GL00	C18-02M	C18-02-FKG0	CB6-04AG	CB6-04-F00
B18-04MMB	B18-04-GL00	C18-03M	C18-03-FKG0	CB6-04AGMB	CB6-04-FG0
B28-03A	B28-03-FG00	C18-04M	C18-04-FKG0	CB6-04MG	CB6-04-000
B28-04A	B28-04-FG00	C18-02AMB	C18-02-FHG0	CB6-04MGMB	CB6-04-G00
B28-06A	B28-06-FG00	C18-03AMB	C18-03-FHG0	CB6-04AMB	CB6-04-FM0
B28-03M	B28-03-FK00	C18-04AMB	C18-04-FHG0	CB6-04MMB	CB6-04-G00
B28-04M	B28-04-FK00	C18-02MMB	C18-02-FLG0	F03-01A	F03-01-D00
B28-06M	B28-06-FK00	C18-03MMB	C18-03-FLG0	F03-02A	F03-02-D00
B28-03AMB	B28-03-GH00	C18-04MMB	C18-04-FLG0	F03-01AMB	F03-01-DM0
B28-04AMB	B28-04-GH00	C26-02A	C26-02-F00	F03-02AMB	F03-02-DM0
B28-06AMB	B28-06-GH00	C26-02M	C26-02-000	F03-01M	F03-01-000
B28-03MMB	B28-03-GL00	C26-02AMB	C26-02-FG0	F03-02M	F03-02-000
B28-04MMB	B28-04-GL00	C26-02MMB	C26-02-G00	F03-01MMB	F03-01-M00
B28-06MMB	B28-06-GL00	C26-03A	C26-03-F00	F03-02MMB	F03-02-M00
BB3-01AG	BB3-01-FRG0	C26-03M	C26-03-000	F08-01A	F08-01-SR00
BB3-02AG	BB3-02-FRG0	C26-03AMB	C26-03-FG0	F08-02A	F08-02-SR00
BB3-01AGMB	BB3-01-FSG0	C26-03MMB	C26-03-G00	F08-01M	F08-01-SK00
BB3-02AGMB	BB3-02-FSG0	C26-04A	C26-04-F00	F08-02M	F08-02-SK00
BB3-01MG	BB3-01-FKG0	C26-04M	C26-04-000	F08-01AMB	F08-01-SS00
BB3-01MGMB	BB3-01-FLG0	C26-04AMB	C26-04-FG0	F08-02AMB	F08-02-SS00
BB3-02MG	BB3-02-FKG0	C26-04MMB	C26-04-G00	F08-01MMB	F08-01-SL00
BB3-02MGMB	BB3-02-FLG0	C28-03A	C28-03-FGG0	F08-02MMB	F08-02-SL00
C03-01A	C03-01-D000	C28-04A	C28-04-FGG0	F16-02A	F16-02-F00
C03-01M	C03-01-0000	C28-06A	C28-06-FGG0	F16-03A	F16-03-F00
C03-02A	C03-02-D000	C28-03M	C28-03-FKG0	F16-04A	F16-04-F00
C03-02M	C03-02-0000	C28-04M	C28-04-FKG0	F16-02M	F16-02-000
C03-01AMB	C03-01-DM00	C28-06M	C28-06-FKG0	F16-03M	F16-03-000
C03-01MMB	C03-01-M000	C28-03AMB	C28-03-FHG0	F16-04M	F16-04-000
C03-02AMB	C03-02-DM00	C28-04AMB	C28-04-FHG0	F16-02AMB	F16-02-FG0
C03-02MMB	C03-02-M000	C28-06AMB	C28-06-FHG0	F16-03AMB	F16-03-FG0
C08-01A	C08-01-FRG0	C28-03MMB	C28-03-FLG0	F16-04AMB	F16-04-FG0
C08-01M	C08-01-FKG0	C28-04MMB	C28-04-FLG0	F16-02MMB	F16-02-G00
C08-02A	C08-02-FRG0	C28-06MMB	C28-06-FLG0	F16-03MMB	F16-03-G00
C08-02M	C08-02-FKG0	C31-06A	C31-06-F00	F16-04MMB	F16-04-G00
C08-01AMB	C08-01-LSG0	C31-06M	C31-06-000	F18-02A	F18-02-SG00

Cross Reference

Dixon	Wilkerson	Dixon	Wilkerson	Dixon	Wilkerson	Dixon	Wilkerson
F18-03A	F18-03-SG00	L08-02A	L08-02-KK00	M18-04M	M18-04-CK00	R26-03R	R26-03-000
F18-04A	F18-04-SG00	L08-01AMB	L08-01-KL00	M26-02A	M26-02-F00	R26-04RG	R26-04-H00
F18-02M	F18-02-SK00	L08-02AMB	L08-02-KL00	M26-03A	M26-03-F00	R26-04RH	R26-04-G00
F18-03M	F18-03-SK00	L16-02A	L16-02-000	M26-04A	M26-04-F00	R26-04RHG	R26-04-GH0
F18-04M	F18-04-SK00	L16-03A	L16-03-000	M26-02M	M26-02-000	R26-04R	R26-04-000
F18-02AMB	F18-02-SH00	L16-04A	L16-04-000	M26-03M	M26-03-000	R28-03R	R28-03-F000
F18-03AMB	F18-03-SH00	L16-02AMB	L16-02-G00	M26-04M	M26-04-000	R28-04R	R28-04-F000
F18-04AMB	F18-04-SH00	L16-03AMB	L16-03-G00	M28-03A	M28-03-CG00	R28-06R	R28-06-F000
F18-02MMB	F18-02-SL00	L16-04AMB	L16-04-G00	M28-04A	M28-04-CG00	R30-06RG	R30-06-G00
F18-03MMB	F18-03-SL00	L18-02A	L18-02-KK00	M28-06A	M28-06-CG00	R30-06RH	R30-06-H00
F18-04MMB	F18-04-SL00	L18-03A	L18-03-KK00	M28-03M	M28-03-CK00	R30-06RHG	R30-06-GH0
F23-04M	F23-04-000	L18-04A	L18-04-KK00	M28-04M	M28-04-CK00	R30-06R	R30-06-000
F26-02A	F26-02-F00	L18-02AMB	L18-02-KL00	M28-06M	M28-06-CK00	R30-08RG	R30-08-G00
F26-03A	F26-03-F00	L18-03AMB	L18-03-KL00	M30-04A	M30-04-F00	R30-08RH	R30-08-H00
F26-04A	F26-04-F00	L18-04AMB	L18-04-KL000	M30-06A	M30-06-F00	R30-08RHG	R30-08-GH0
F26-02M	F26-02-000	L26-02A	L26-02-000	M30-08A	M30-08-F00	R30-08R	R30-08-000
F26-03M	F26-03-000	L26-03A	L26-03-000	M32-0AAMB	M32-0A-F00	R30-0ARG	R30-0A-G00
F26-04M	F26-04-000	L26-04A	L26-04-000	M35-0BAMB	M35-0B-F00	R30-0ARH	R30-0A-H00
F26-02AMB	F26-02-FG0	L26-02AMB	L26-02-G00	M35-0CAMB	M35-0C-F00	R30-0ARHG	R30-0A-GH0
F26-03AMB	F26-03-FG0	L26-03AMB	L26-03-G00	R03-01R	R03-01-000	R30-0AR	R30-0A-000
F26-04AMB	F26-04-FG0	L26-04AMB	L26-04-G00	R03-02R	R03-02-000	R40-0BRG	R30-0B-G00
F26-02MMB	F26-02-G00	L28-03A	L28-03-KK00	R03-01RG	R03-01-G00	R40-0BRH	R40-0B-H00
F26-03MMB	F26-03-G00	L28-04A	L28-04-KK00	R03-02RG	R03-02-G00	R40-0BRHG	R40-0B-GH0
F26-04MMB	F26-04-G00	L28-06A	L28-06-KK00	R08-01RG	R08-01-F0G0	R40-0BR	R40-0B-000
F28-03A	F28-03-SG00	L28-03AMB	L28-03-KL00	R08-01R	R08-01-F000	R40-0CRG	R40-0C-G00
F28-04A	F28-04-SG00	L28-04AMB	L28-04-KL00	R08-02RG	R08-02-F0G0	R40-0CRH	R40-0C-H00
F28-06A	F28-06-SG00	L28-06AMB	L28-06-KL00	R08-02R	R08-02-F000	R40-0CRHG	R40-0C-GH0
F28-03M	F28-03-SK00	L30-06A	L30-06-000	R16-02R	R16-02-000	R40-0CR	R40-0C-000
F28-04M	F28-04-SK00	L30-08A	L30-08-000	R16-02RG	R16-02-G00	RB3-01R	RB-01-R000
F28-06M	F28-06-SK00	L30-06AMB	L30-06-G00	R16-02RH	R16-02-H00	RB3-01RG	RB-01-R0G0
F28-03AMB	F28-03-SH00	L30-08AMB	L30-08-G00	R16-02RHG	R16-02-GH0	RB3-02R	RB3-02-R000
F28-04AMB	F28-04-SH00	L40-0AA	L40-0A-000	R16-03RG	R16-03-G00	RB3-02RG	RB3-02-R0G0
F28-06AMB	F28-06-SH00	L40-0BA	L40-0B-000	R16-03R	R16-03-000	X02-04	X02-04-000
F28-03MMB	F28-03-SL00	L40-0CA	L40-0C-000	R16-03RH	R16-03-H00	X02-04MB	X02-04-M00
F28-04MMB	F28-04-SL00	L40-0AAMB	L40-0A-G00	R16-03RHG	R16-03-GH0	X03-02	X03-02-000
F28-06MMB	F28-06-SL00	L40-0BAMB	L40-0B-G00	R16-04RG	R16-04-G00	X03-02MB	X03-02-M00
F30-06A	F30-06-F00	L40-0CAMB	L40-0C-G00	R16-04RH	R16-04-H00	X51-02	X51-02-000
F30-08A	F30-08-F00	L50-0CAMB	L50-0C-G00	R16-04RHG	R16-04-GH0		
F30-06M	F30-06-000	LV4N6D	LV4N6B	R16-04R	R16-04-000		
F30-08M	F30-08-000	LV6N6D	LV6N6B	R18-02R	R18-02-F0G0		
F30-06AMB	F30-06-FG0	LV6NAD	LV6NAB	R18-03R	R18-03-F0G0		
F30-08AMB	F30-08-FG0	LV8NAD	LV8NAB	R18-04R	R18-04-F000		
F30-06MMB	F30-06-G00	M16-02A	M16-02-F00	R21-02R	R21-02-000		
F30-08MMB	F30-08-G00	M16-03A	M16-03-F00	R21-03R	R21-03-000		
F35-0BAMB	F35-0B-F00	M16-04A	M16-04-F00	R21-04R	R21-04-000		
F35-0CAMB	F35-0C-F00	M16-02M	M16-02-000	R21-06R	R21-06-000		
F35-0BMMB	F35-0B-000	M16-03M	M16-03-000	R26-02RG	R26-02-G00		
F35-0CMMB	F35-0C-000	M16-04M	M16-04-000	R26-02RH	R26-02-H00		
L03-01A	L03-01-000	M18-02A	M18-02-CG00	R26-02RHG	R26-02-GH0		
L03-02A	L03-02-000	M18-03A	M18-03-CG00	R26-02R	R26-02-000		
L03-01AMB	L03-01-M00	M18-04A	M18-04-CG00	R26-03RG	R26-03-G00		
L03-02AMB	L03-02-M00	M18-02M	M18-02-CK00	R26-03RH	R26-03-H00		
L08-01A	L08-01-KK00	M18-03M	M18-03-CK00	R26-03RHG	R26-03-GH0		

