

Wilkerson FRLs

Flow Guide®

The elastomer disc-shaped device is located in the throat of all Wilkerson lubricators and automatically maintains a constant ratio of oil flow to airflow regardless of changing rates of airflow. This allows one lubricator to serve several pneumatic components operating together or intermittently.

Type of oil to use

For all Wilkerson lubricators, use any petroleum-base, non-detergent light weight oil (SAE 10/150SSU) which will readily break up into a mist, i.e., Mobil DTE light or comparable oil. Do not use synthetic oil or any oils containing additives or solvents. See page 273 for air tool lubricants.

L18-Series EconOmist® Compact Lubricators

Features

- 4 oz. bowl
- Manual drain
- High flow capacity
- Can be filled under pressure
- To adjust and set oil delivery rate the unit must be pressurized and air must be flowing through the unit. Turn the sight dome, located on the top of the unit, counter clockwise to initiate oil delivery. The rate of oil delivery depends on air flow rate. If flow increases or decreases, the oil delivery rate will increase or decrease proportionally. Turning the sight dome clockwise will stop all oil delivery

Specifications

- Maximum operating conditions:
 - transparent bowl: 150 PSIG (10.3 bar) and 14°F to 125°F (-10°C to 52°C)
 - metal bowl: 250 PSIG (17.2 bar) and 14°F to 150°F (-10°C to 65.5°C)

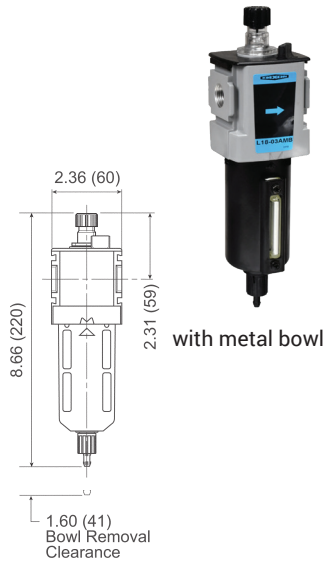

Size	Flow (SCFM)	Transparent Bowl Part #	Metal Bowl Part #
1/4"	88	L18-02A	L18-02AMB
3/8"	90	L18-03A	L18-03AMB
1/2"	96	L18-04A	L18-04AMB

L26-Series EconOmist® Standard Lubricators

Features

- 10 oz. bowl
- Adjustable oil feed
- Can be filled under pressure
- Quick-disconnect metal bowl guard with integral safety latch
- Siphon tube filter provides clean lubricant downstream
- The rate of oil delivery may be controlled by turning the adjusting screw counter clockwise for more and clockwise for less oil delivery. If flow increases or decreases, the oil delivery rate will increase or decrease proportionally

Specifications

- Maximum operating conditions:
 - transparent bowl: 150 PSIG (10.3 bar) and 32°F to 125°F (0°C to 52°C)
 - metal bowl: 200 PSIG (13.8 bar) and 32°F to 150°F (0°C to 66°C)



Size	Flow (SCFM)	Transparent Bowl Part #	Metal Bowl ¹ Part #
3/8"	60	L26-03A	L26-03AMB
1/2"	128	L26-04A	L26-04AMB

¹ Metal bowl has sight gauge with brass petcock drain

NOTE: SCFM ratings at 150 PSIG inlet pressure.

See pages 322-326 for accessories.

See page 273 for air tool lubricant.

FRLs are designed for air service only, unless otherwise indicated.



F